

A41-L Series

All-4-One™ International Transformers
with Lead Wires

International Standards at Lower Cost and Better Performance

Designed to provide the high isolation, creepage and clearance necessary to comply with international safety standards.

General Specifications

- Power - 25 VA to 175 VA
- Dielectric Strength - 4000 Vrms Hipot
- Primaries - Dual primaries (115/230 V - 50/60 Hz)
- Dual Secondaries - Series or parallel
- Terminals - Solder lug / quick connect type terminals
- Leakage - Current meets UL 60601-1, IEC/EN 60601-1
- Insulation - Class F (155° C)
- Flammability Rating - Bobbin and shroud material meet UL 94-V0



Agency Certifications

- UL 1446 UL File # E66312
- UL recognized to UL 506 / UL 5085-2, File # E63829
- CSA certified to C22.2 No 66.1, File # 221070
- VDE certified to VDE 0868 / EN 62368, File # 1448
- CE Compliance VDE Declaration of Conformity LVD 2014/35/EU

Lead Wires

- Hook up lead wire style UL1015, CSA TEW
- Rated 600 V -40° to +105° C
- Passes UL VW-1 (flame test)
- All primary lead wires are 18 AWG UL 1015
- All lead wires are 12" in length



A41-L Series Datasheet

Part Number Selection

Part Number	VA	Secondary RMS Rating		Lead Wire Gauge
	Size	Series	Parallel	Secondary
A41-25-10L	25	10.0 VCT @ 2.5 A	5.0 V @ 5.0 A	18 AWG
A41-43-10L	43	10.0 VCT @ 4.3 A	5.0 V @ 8.6 A	18 AWG
A41-80-10L	80	10.0 VCT @ 8.0 A	5.0 V @ 16.0 A	18 AWG
A41-130-10L	130	10.0 VCT @ 13.0 A	5.0 V @ 26.0 A	16 AWG
A41-175-10L	175	10.0 VCT @ 17.5 A	5.0 V @ 35.0 A	16 AWG
A41-25-12L	25	12.6 VCT @ 2.0 A	6.3 V @ 4.0 A	18 AWG
A41-43-12L	43	12.6 VCT @ 3.4 A	6.3 V @ 6.8 A	18 AWG
A41-80-12L	80	12.6 VCT @ 6.3 A	6.3 V @ 12.6 A	18 AWG
A41-130-12L	130	12.6 VCT @ 10.3 A	6.3 V @ 20.6 A	16 AWG
A41-175-12L	175	12.6 VCT @ 14.0 A	6.3 V @ 28.0 A	16 AWG
A41-25-16L	25	16.0 VCT @ 1.6 A	8.0 V @ 3.2 A	18 AWG
A41-43-16L	43	16.0 VCT @ 2.7 A	8.0 V @ 5.4 A	18 AWG
A41-80-16L	80	16.0 VCT @ 5.0 A	8.0 V @ 10.0 A	18 AWG
A41-130-16L	130	16.0 VCT @ 8.1 A	8.0 V @ 16.2 A	16 AWG
A41-175-16L	175	16.0 VCT @ 11.0 A	8.0 V @ 22.0 A	16 AWG
A41-25-20L	25	20.0 VCT @ 1.25 A	10 V @ 2.5 A	18 AWG
A41-43-20L	43	20.0 VCT @ 2.2 A	10 V @ 4.4 A	18 AWG
A41-80-20L	80	20.0 VCT @ 4.0 A	10 V @ 8.0 A	18 AWG
A41-130-20L	130	20.0 VCT @ 6.5 A	10 V @ 13.0 A	16 AWG
A41-175-20L	175	20.0 VCT @ 8.8 A	10 V @ 17.6 A	16 AWG

Part Number	VA	Secondary RMS Rating		Lead Wire Gauge
	Size	Series	Parallel	Secondary
A41-25-24L	25	24 VCT @ 1.0 A	12 V @ 2.0 A	18 AWG
A41-43-24L	43	24 VCT @ 1.8 A	12 V @ 3.6 A	18 AWG
A41-80-24L	80	24 VCT @ 3.3 A	12 V @ 6.6 A	18 AWG
A41-130-24L	130	24 VCT @ 5.4 A	12 V @ 10.8 A	16 AWG
A41-175-24L	175	24 VCT @ 7.3 A	12 V @ 14.6 A	16 AWG
A41-25-28L	25	28 VCT @ 0.9 A	14 V @ 1.86 A	18 AWG
A41-43-28L	43	28 VCT @ 1.5 A	14 V @ 3.0 A	18 AWG
A41-80-28L	80	28 VCT @ 2.8 A	14 V @ 5.6 A	18 AWG
A41-130-28L	130	28 VCT @ 4.6 A	14 V @ 9.2 A	16 AWG
A41-175-28L	175	28 VCT @ 6.25 A	14 V @ 12.5 A	16 AWG
A41-25-36L	25	36 VCT @ 0.7 A	18 V @ 1.4 A	18 AWG
A41-43-36L	43	36 VCT @ 1.2 A	18 V @ 2.4 A	18 AWG
A41-80-36L	80	36 VCT @ 2.2 A	18 V @ 4.4 A	18 AWG
A41-130-36L	130	36 VCT @ 3.6 A	18 V @ 7.2 A	18 AWG
A41-175-36L	175	36 VCT @ 4.8 A	18 V @ 9.6 A	16 AWG
A41-25-230L	25	230 VCT @ 0.11 A	115 V @ 0.22 A	18 AWG
A41-43-230L	43	230 VCT @ 0.19 A	115 V @ 0.38 A	18 AWG
A41-80-230L	80	230 VCT @ 0.35 A	115 V @ 0.7 A	18 AWG
A41-130-230L	130	230 VCT @ 0.57 A	115 V @ 1.14 A	18 AWG
A41-175-230L	175	230 VCT @ 0.76 A	115 V @ 1.52 A	18 AWG



Custom versions available upon request.



128 Atlantic Avenue, Lynbrook, NY 11563
 Toll Free 866-239-5777 | Tel 516-239-5777 | Fax 516-239-7208
 sales@signaltransformer.com | techhelp@signaltransformer.com

belfuse.com/signal

A41-L Series Datasheet

Mechanical Specifications

VA	Mechanical Dimensions					Lead Wire Length Standard	Mounting Style	Mounting Dimensions		Mounting Screw	Weight lbs (kg)
	L	W	H	A	B			ML	MW		
Size	Inches (mm)					Inches (mm)					
25	2.81 (71.4)	2.14 (54.4)	2.31 (58.7)	2.00 (50.8)	1.12 (28.6)	12.0 (304.8)	C	2.37 (60.3)	—	#6	1.25 (0.57)
43	3.12 (79.4)	2.14 (54.4)	2.68 (68.2)	2.25 (57.2)	1.12 (28.6)	12.0 (304.8)	C	2.81 (71.4)	—	#6	1.6 (0.73)
80	2.50 (63.5)	2.52 (64.3)	3.06 (77.7)	—	1.37 (35.0)	12.0 (304.8)	B	2.00 (50.8)	2.18 (55.5)	#6	2.8 (1.27)
130	2.81 (71.4)	3.00 (76.2)	3.37 (85.7)	—	1.62 (41.3)	12.0 (304.8)	B	2.25 (57.2)	2.50 (63.5)	#8	4.1 (1.86)
175	3.12 (79.4)	3.14 (79.7)	3.75 (95.3)	—	1.62 (41.3)	12.0 (304.8)	B	2.50 (63.5)	2.50 (63.5)	#8	5.5 (2.49)

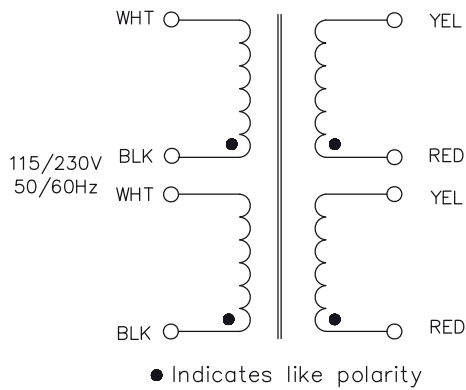
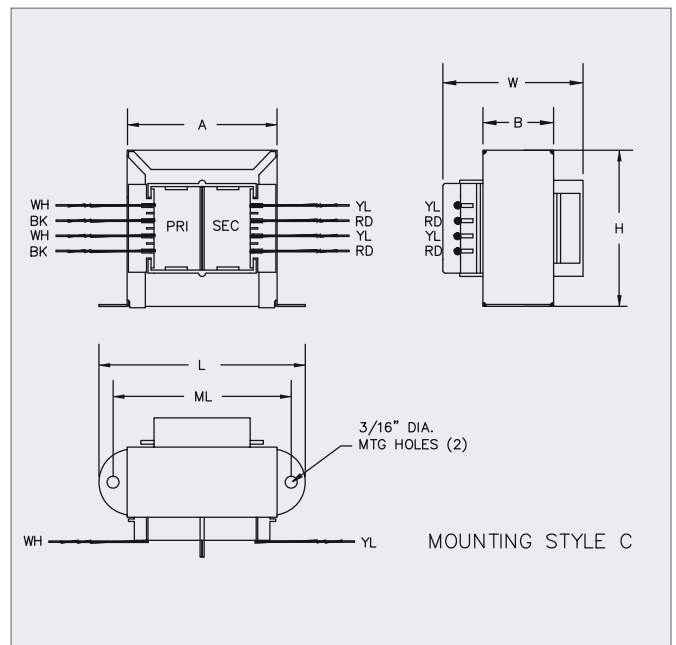
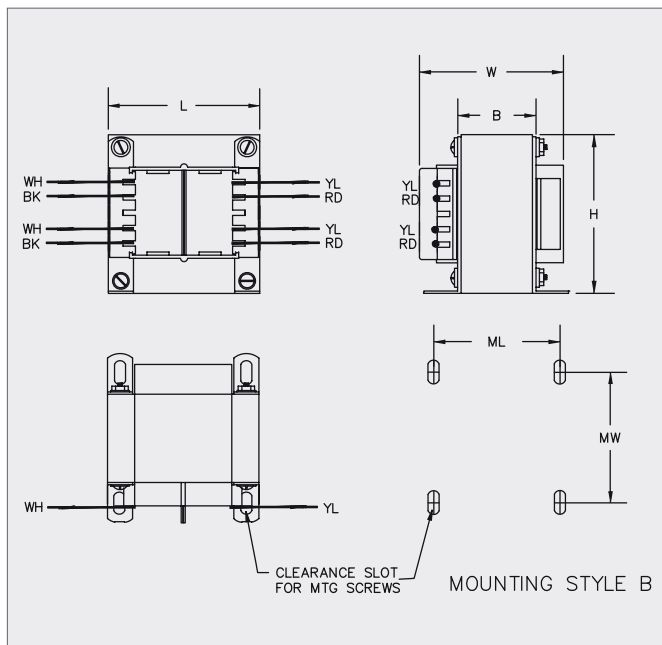

Custom versions available upon request.



128 Atlantic Avenue, Lynbrook, NY 11563
Toll Free 866-239-5777 | Tel 516-239-5777 | Fax 516-239-7208
sales@signaltransformer.com | techhelp@signaltransformer.com

belfuse.com/signal