

# MBS400 Series

## 400 W AC-DC Power Supplies

### Sealed IP67

### Medical

The MBS400 Series of AC-DC power supplies provides up to 400 W of regulated output power through wide input voltage range 90 – 264 VAC in single outputs of 12, 24, 36 or 48 VDC.

The MBS400 Series comes in a 83.0 x 212.0 x 42.0 mm form factor, offering 12 and 5 VSB standby outputs and a full set of protection features. Available control signals include Power Good (Power\_OK), remote On/off (PS\_ON) and remote sense (+RS).

The sealed and full potted package allows an IP67 ingress protection index and can be installed in contact with thermo-conductive part of the system to transfer heat by conduction.

The MBS400 Series complies with the latest international safety standards for medical equipment, offering 2x MoPP protection grade and displays the CE-Mark for the European Low Voltage Directive (LVD).

#### Key Features & Benefits

- Universal input voltage range (90 – 264 V<sub>AC</sub>)
- Input surge current limiting
- 400 W rated power (440 W peak up to 10 s)
- High efficiency up to 94%
- Low stand-by consumption (<0.5 W)
- 12, 24, 36 and 48 V standard output voltages
- Active PFC, EN61000-3-2 compliant (Class C, >25% load).
- Low earth / touch leakage current
- Over temperature protection, OV, OC and SC protections
- Stand by +5 V, 2 A and auxiliary / fan 12 V<sub>DC</sub>, 1 A outputs.
- Remote On / Off signal
- Power good and remote sense signals
- Sealed, potted package IP67 rated, fits 1U applications
- Medical safety approval to IEC 60601-1 3rd edition, 2x MoPP rated and BF appliances compatible.
- EN 60601-1-2 4th ed. for immunity compliance
- RoHS 3 compliant (Directive 2015/863/EU)
- Medical version compatible with 4000 m altitude operation
- Optional heatsink accessory available (HSKIT-400-XBS)

#### Applications

- Computed tomography imaging
- Dialysis and ultrasound equipment
- Operating room equipment
- Laboratory and clean room equipment
- Ventilators

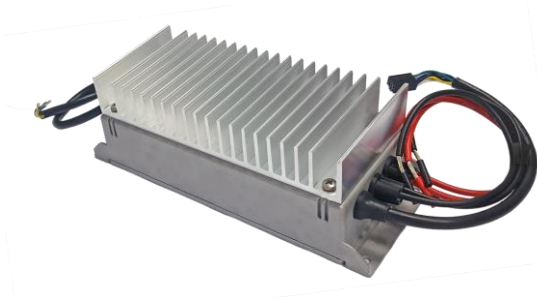

**bel** POWER  
SOLUTIONS &  
PROTECTION

a bel group

[belfuse.com/power-solutions](http://belfuse.com/power-solutions)

## 1. MODEL SELECTION

MODEL NUMBER	PACKAGE & COOLING	INPUT VOLTAGE RANGE [VAC]	NOM. OUTPUT VOLTAGE [VDC]	MAX. OUTPUT POWER [W]	MAX. OUTPUT CURRENT [A]	DIMENSIONS
MBS400-1012	Sealed Chassis Convection / Conduction	90 - 264	12	400	33.3	Dimensions without heatsink: 83.0 x 212.0 x 42.0 mm 3.27 x 8.34 x 1.65 in
MBS400-1024	Sealed Chassis Convection / Conduction	90 - 264	24	400	16.7	
MBS400-1036	Sealed Chassis Convection / Conduction	90 - 264	36	400	11.1	Dimensions with heatsink: 83.0 x 212.0 x 70.1 mm 3.27 x 8.34 x 2.76 in
MBS400-1048	Sealed Chassis Convection / Conduction	90 - 264	48	400	8.3	
HSKIT-400-XBS	- Heatsink accessory (optional) Mounting kit includes 4x screws, M4x10, and the thermally conductive graphite sheet					

## 2. INPUT SPECIFICATIONS

PARAMETER	DESCRIPTION / CONDITION	MIN	NOM	MAX	UNIT	
AC Input Voltage	PS starts and operates at 90 V <sub>AC</sub> at all load conditions	90	100-240	264	V <sub>RMS</sub>	
DC Input Voltage		170	-	270	V <sub>DC</sub>	
Input Frequency		47	50/60	440	Hz	
Input Current	RMS at 180 V <sub>AC</sub> , maximum load, 50 / 60 Hz RMS at 90 V <sub>AC</sub> , maximum load, 50 / 60 Hz	-	-	2.5 5.0	A	
Inrush Current	265 V <sub>AC</sub> , 25 °C ambient, cold start.			20	A	
Fusing	2x Time Lag 6.3 A, 250 V on both L and N	-	-	6.3	A	
Efficiency	At 115 V <sub>AC</sub>	20% rated load	90	-	-	%
		100 % load	92	-	-	
	At 230 V <sub>AC</sub>	20% full load	90	-	-	
		50 – 100 % full load	94	-	-	
Input Power Consumption	Power on, 115-230 V <sub>RMS</sub> , no load Stand by, 115-230 V <sub>RMS</sub> , no load	-	1 0.4	1.5 0.5	W	
Power Factor	At full rated load, 115 VAC, 60 Hz and 230 VAC, 50 Hz input voltages	0.95	-	-	-	
Harmonic Current Fluctuations and Flicker	Complies with EN-61000-3-2 Class C at 230 VAC 50 Hz, load >50 W. Complies with EN-61000-3-3 at nominal voltages and full load.					
Leakage Current	Normal conditions, 240 V <sub>RMS</sub> , 60 Hz.			300	µA	

## 3. OUTPUT SPECIFICATIONS

PARAMETER	DESCRIPTION / CONDITION	MIN	NOM	MAX	UNIT	
V1 Output Voltage	±0.5% set point accuracy on all outputs	-	12	-	V	
		-	24	-		
		-	36	-		
		-	48	-		
V1 Output Power Rating	All models, convection cooling	-	-	350	W	
	All models, conduction cooling / heat sink	-	-	400		
	All models, peak power (≤ 10 s)	-	-	440		
V1 Output Current	* Conduction (with heatsink)	V1: 12 V <sub>DC</sub>		33.3	A	
		V1: 24 V <sub>DC</sub>		16.7		
		V1: 36 V <sub>DC</sub>		11.1		
	** Convection (without heatsink)	V1: 48 V <sub>DC</sub>		8.3	A	
		V1: 12 V <sub>DC</sub>		29.2		
		V1: 24 V <sub>DC</sub>		14.6		
		V1: 36 V <sub>DC</sub>		9.7		
		V1: 48 V <sub>DC</sub>		7.3		
V1 Voltage Adjustment Range		±5	-	-	%V1	
V1 Load-Line-Cross Regulation	V <sub>AC</sub> : 90 – 264 V <sub>RMS</sub>			±2	%V1	
V1 Line Regulation	V <sub>AC</sub> : 90 – 264 V <sub>RMS</sub>	-	-	±0.1	%V1	
Transient Response (Voltage Deviation) V1, 5V <sub>SB</sub>	25% load changes at 1 A/μs					
	12 V at 2200 μF Load / I <sub>OUT</sub> > 0.5 A					
	24 V at 1000 μF Load / I <sub>OUT</sub> > 0.5 A					
	36 V at 820 μF Load / I <sub>OUT</sub> > 0.5 A					
	48 V at 560 μF Load / I <sub>OUT</sub> > 0.5 A					
	5V <sub>SB</sub> at 560 μF Load / I <sub>OUT</sub> > 0.1 A					
				±5	%V1 %5V <sub>SB</sub>	
V1 Ripple & Noise	All models, Peak-to-peak, 20 MHz BW. 100 nF ceramic and 10μF tantalum to the load.	-	-	1	%V1	
Start-up Rise Time	90<V <sub>IN</sub> <264, any load conditions.	5	-	85	ms	
Start-up Delay	V1 in regulation after PS_ON is asserted			200	ms	
	V1 in regulation after AC is applied			750		
	5V <sub>SB</sub> in regulation after AC is applied			500		
Turn-on Overshoot	At 500 mA output current, V1 in regulation within 50 ms.		10		%V1	
			10		%V2	
			10		%V <sub>SB</sub>	
Hold-up Time	At nominal V <sub>IN</sub> , 400 W, for all outputs	-	16	-	ms	
	At nominal V <sub>IN</sub> , 365 W, for all outputs	-	20	-		
	At nominal V <sub>IN</sub> , 200 W, for all outputs	-	35	-		
Minimum Load ***	All models; V1, V2 and 5V <sub>SB</sub>	0	-	-	A	
Maximum Load Capacitance	At nominal V <sub>IN</sub> , 25 °C ambient	12 V	-	-	33000	μF
		24 V	-	-	16000	
		36 V	-	-	10000	
		48 V	-	-	7000	
Temperature Drift		-1.2	-	+1.2	mV/°C	
V2 Output Voltage	All versions.					
	Load on V2: from 5 to 1000 mA Load on V1: from 0.1 to 16.7 A	11.25	12.5	13.75	V	
V2 Output Current	All models, convection/forced air cooling	-	-	1	A	
V2 Ripple	Peak-to-Peak measured at 20 MHz Bandwidth.			240	mV	
5V <sub>SB</sub> Output Voltage	All models (3% set point accuracy)	-	5	-	V	
5V <sub>SB</sub> Output Current	All models, convection cooling	-	-	1.5	A	
	All models, conduction cooling / heat sink	-	-	2		

5V <sub>SB</sub> Load-Line-Cross Regulation	V <sub>AC</sub> : 90 – 264 V <sub>RMS</sub>	V1 Load: 0 – 33.3 A (12 V)	-	-	±5	%5V <sub>SB</sub>
		0 – 16.7 A (24 V)				
5V <sub>SB</sub> Ripple	Peak-to-Peak measured at 20 MHz Bandwidth.	0 – 11.1 A (36 V)	50	mV		
		0 – 8.3 A (48 V)				
		V2 Load: 0 – 1 A 5V <sub>SB</sub> Load: 0 – 2 A				

- \* The combined output power of V1, V2 and 5V<sub>SB</sub> for all models, when conduction cooled or convection cooled with heat sink mounted, must not exceed 400 W up to 50 °C, and 300 W at 70 °C ambient temperature.
- \*\* The combined output power of V1, V2 and 5 V<sub>SB</sub> for all models, when convection cooled and V<sub>IN</sub> ≥ 180 V<sub>RMS</sub>, must not exceed 350 W up to 50 °C, and 240 W at 70 °C ambient temperature. See de-rating curves below.
- \*\*\* When the load on the main output is less than 100 mA, V2 output voltage might regulate below its minimum value. Contact Bel for details.

### 3.1 OUTPUT POWER DE-RATING CURVES

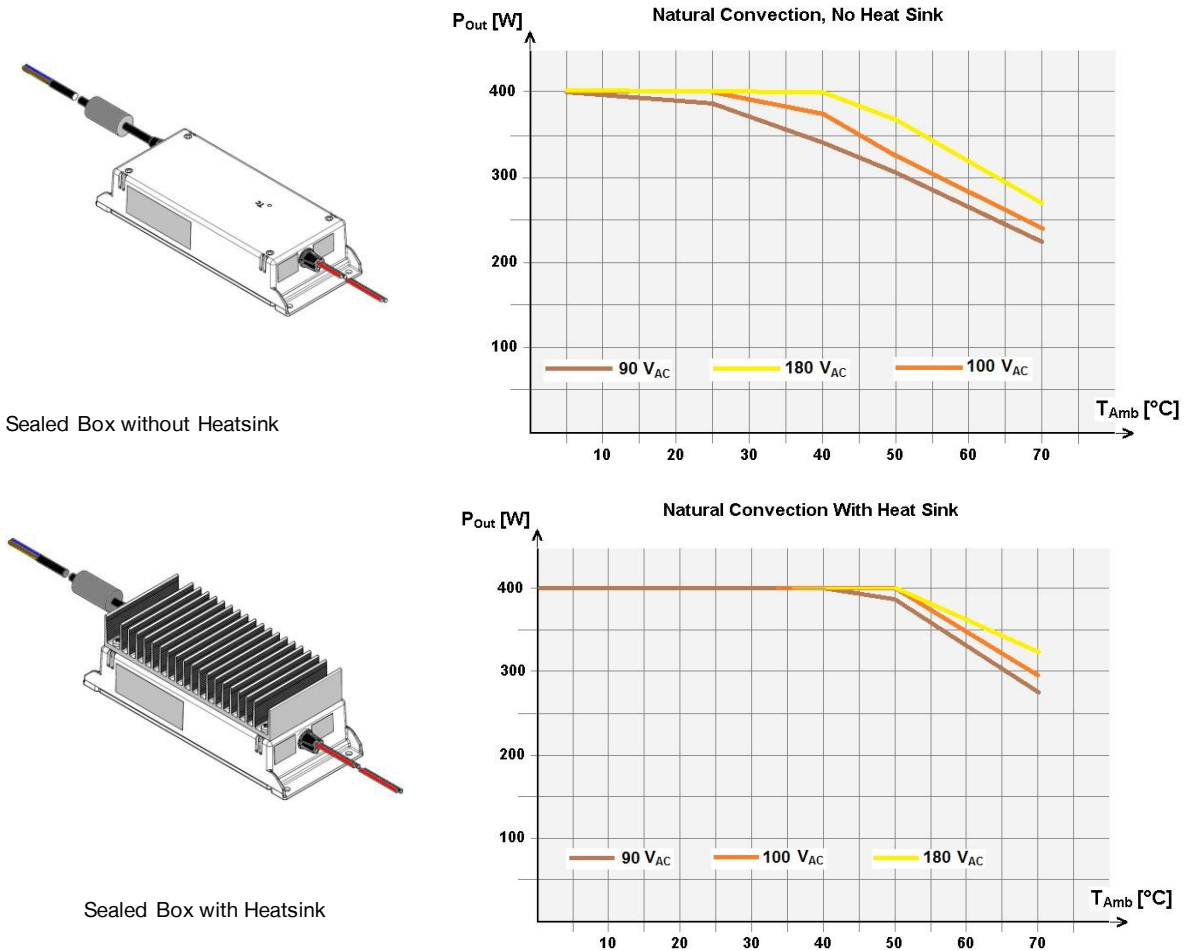
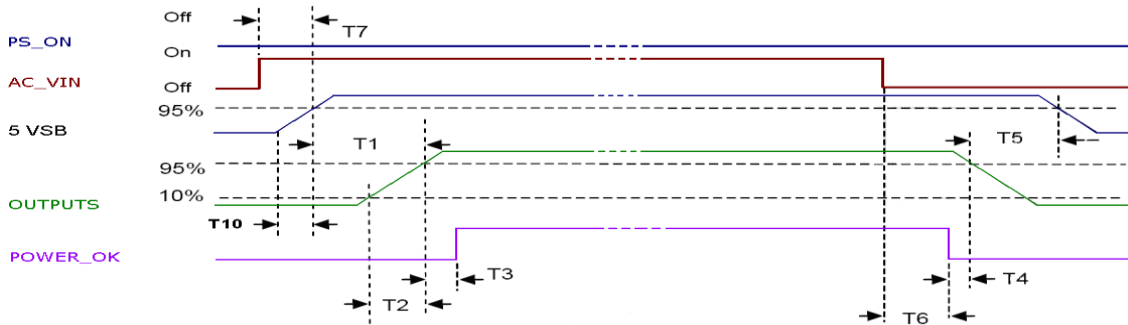

Figure 2. Power Derating Curves

## 4. SIGNALS, CONTROLS & TIMING SPECIFICATIONS

Base signals and controls are accessible from signal connector P204.

SIGNAL	DESCRIPTION / CONDITION	MIN	NOM	MAX	UNIT
<b>PS_ON</b>	Active low, +5 V TTL signal compatible. Input low voltage	0	-	2.0	V
	Input high voltage ( $I_{IN} = 200 \mu A$ )	3.0	-	-	V
	V1 and V2 disabled when PS_ON is open				
	5V <sub>SB</sub> not affected by PS_ON				
	V1 and V2 enabled with PS_ON connected to RTN				
<b>P_OK</b>	+5 V TTL compatible				
	Logic level low (<10 mA sinking)	-	-	0.7	V
	Logic level high (100 $\mu A$ sourcing)	2.4	-	5	V
	Low to high time after V1 in regulation	0.05	-	0.1	s
	Power down warning time	1	-	-	ms
<b>5V<sub>SB</sub> output</b>	Active and in regulation after a $90 < V_{AC} < 264$ is applied	-	-	200	ms
	5V <sub>SB</sub> not affected by PS_ON				



Above waveforms are expected with AC Input ON/OFF:

Standby on - Main outputs on	$50 \text{ ms} \leq T1 \leq 250 \text{ ms}$
Main output Rise Time	$5 \text{ ms} \leq T2 \leq 110 \text{ ms}$
5 V <sub>SB</sub> rise time	$4 \text{ ms} \leq T10 \leq 20 \text{ ms}$
Main outputs On – P_OK delay	$25 \text{ ms} \leq T3 \leq 100 \text{ ms}$
Power down warning <sup>1</sup>	$T4 \geq 1 \text{ ms}$
Main Output off – Standby off <sup>2</sup>	$T5 \geq 1.2 \text{ s}$
Hold-up time (AC off – P_OK low)	$T6 \geq 15 \text{ ms (115/ 230 VAC)}$
AC_ON - Standby turn on time	$T7 \leq 500 \text{ ms}$

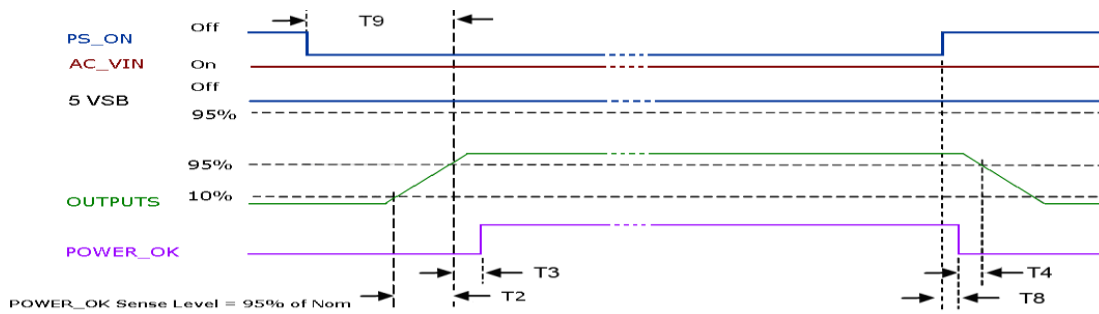

Above waveforms are expected with PS\_ON Signal ON/OFF state change:

Main Output Rise Time	$5 \text{ ms} \leq T2 \leq 110 \text{ ms}$
Main Outputs on – P_OK delay	$25 \text{ ms} \leq T3 \leq 100 \text{ ms}$
Power down warning <sup>1</sup>	$1 \text{ ms} \leq T4 \leq 5 \text{ ms}$
PS_ON - Main Output (off) Timing	$T8 \leq 1 \text{ ms}$
PS_ON - Main Output (on) Timing	$T9 \leq 200 \text{ ms}$

<sup>1</sup> T4 parameter measurement setup will assume at least 10% of the maximum load on each output.

<sup>2</sup> T5 parameter measurement setup will assume 50% of the maximum load on 5V<sub>SB</sub>.

## 5. PROTECTION SPECIFICATIONS

PARAMETER	DESCRIPTION / CONDITION	MIN	NOM	MAX	UNIT
Input Under Voltage	Auto-recovering, hiccup mode.	60	75	-	V <sub>AC</sub>
Input Fuse	2x Time Lag 6.3 A, 250 V on L and N	-	-	6.3	A
Over Current	At nominal input voltages. V1: Hiccup mode, auto-recovering. V2: PTC limiting, auto-recovering. 5V <sub>SB</sub> : Hiccup mode, auto-recovering.	110	-	155	%I <sub>MAX</sub>
Short Circuit	At nominal input voltages. V1: Hiccup mode, auto-recovering. V2: PTC limiting, auto-recovering. 5V <sub>SB</sub> : Hiccup mode, auto-recovering.	-	-	-	
Over Voltage	12 V 24 V 48 V 5 V <sub>SB</sub> Shut down, latch-off.	110	-	136	%V <sub>NOM</sub>
Over Temperature (on primary stage)	Shut down, latch off.	-	-	-	
Over Temperature (on secondary side)	Hiccup mode, auto-recovering.	-	-	-	
Isolation Primary to Secondary	Reinforced (2x MoPP)	5660	-	-	V <sub>DC</sub> V <sub>AC</sub>
Isolation Input to Earth	Basic (1x MoPP)	1500	-	-	V <sub>AC</sub>
Isolation V1 to V2	Functional	100	-	-	V <sub>DC</sub>
Isolation Output to Earth	Basic (1x MoPP)	1500	-	-	V <sub>AC</sub>

## 6. ENVIRONMENTAL SPECIFICATIONS

PARAMETER	DESCRIPTION / CONDITION	MIN	NOM	MAX	UNIT
Operating Temperature Range	PS starts up at -30 °C See graphs above for output power de-rating against $T_{Amb}$ and $V_{in}$ .	-20	-	70	°C
Storage Temperature Range		-40	-	85	°C
Humidity	RH, Non-condensing Operating Non-operating	-	-	90 95	% %
Operating Altitude		-	-	4000	m
Shock	<b>EN 60068-2-27</b> Operating: Half sine, 30 g, 18 ms, 3 axes, 6x each (3 positive and 3 negative). Non-Operating: Half sine, 50 g, 11 ms, 3 axes, 6x each (3 positive and 3 negative).				
Vibration	<b>EN 60068-2-64</b> Operating: Sine, 10 – 500 Hz, 1 g, 3 axes, 1 oct/min., 60 min. Random, 5 – 500 Hz, 0.02 $g^2/Hz$ , 1 $g_{RMS}$ , 3 axes, 30 min. Non-Operating: 5 – 500 Hz, 2.46 $g_{RMS}$ (0.0122 $g^2/Hz$ ), 3 axes, 30 min.				
MTBF	Full Load, 120 $V_{AC}$ , 50 °C ambient 70% Duty cycle, Telcordia Issue 1	400000	-	-	Hours
Cooling	Convection with or without heat sink and conduction providing an adequate thermal path between the unit and the external environment. Case hot spot temperature, $T_c$ , should not exceed 90 °C in any working condition.				
Useful Life	Low line range, 200 W, 40 °C ambient, natural convection.	-	4	-	Years

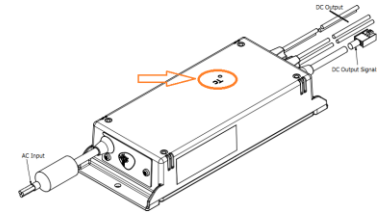

## 7. ELECTROMAGNETIC COMPATIBILITY (EMC) – EMISSIONS

PARAMETER	DESCRIPTION / CONDITION	STANDARD	PERFORMANCE CLASS
Conducted	115 $V_{RMS}$ , 230 $V_{RMS}$ . Maximum load. 4 dB minimum margin	EN 55011 (ISM) EN 60601-1-2 (Medical)	B
Radiated	At 10 m distance	EN 55011 (ISM) EN 60601-1-2 (Medical)	B
Line Voltage Fluctuation and Flicker	At 20%, 50% and 100% maximum load. Nominal input voltages.	EN 61000-3-3	
Harmonic Current Emission	Nominal input voltages. Output load > 50 W.	EN 61000-3-2	C



## 8. ELECTROMAGNETIC COMPATIBILITY (EMC) – IMMUNITY

PARAMETER	DESCRIPTION / CONDITION	STANDARD	TEST LEVEL	CRITERIA
	Reference standard for the medical version	EN 60601-1-2, 4 <sup>th</sup> edition		
ESD	15 kV air discharge, 8 kV contact, at any point of the system.	EN 61000-4-2	4	A
Radiated Field	3 V/m, 80-1000 MHz, 1 KHz/2 Hz 80% AM. Dwell time is 3 sec for 2 Hz modulation Dwell time is 1 sec for 1KHz modulation	EN 61000-4-3	3	A
Electric Fast Transient	±2 kV on AC power port for 1 minute; ±1 kV on signal/control lines	EN 61000-4-4	3	A
Surge	± 2kV line to line; ± 4 KV line to earth; on AC power port; ±0.5 kV for outdoor cables	EN 61000-4-5	3	A B
Conducted RF Immunity	3 V <sub>RMS</sub> , 0, 15-80 MHz, 1 KHz/2 Hz 80% AM	EN 61000-4-6	3	A
Dips and Interruptions	Dip to 30% for 5 cycle (10 ms)	EN61000-4-11		A
	Dip to 40% for 5 cycles (100 ms)	EN61000-4-11		B
	Dip to 70% for 25 cycles (500 ms)	EN61000-4-11		B
	Drop-out to 5% for 10 ms	EN61000-4-11		B
	Interrupts > 95% for 5 s	EN61000-4-11		B

## 9. SAFETY AGENCIES APPROVALS

CERTIFICATION BODY	SAFETY STANDARDS	CATEGORY
CSA/UL	CSA C22.2 No.601.1, ANSI/AAMI ES60601-1 3rd edition	Medical
IEC IECCE CB Certification	IEC/EN 60601-1 3rd edition	Medical
CE	Low Voltage Directive (LDV) 2007/47/EC MDD	Medical

## 10. CONNECTIONS AND PIN DESCRIPTION

CONNECTIONS	WIRES GAUGE AND LENGTH	ASSIGNMENT	COLOUR/PIN
<b>AC Input</b>	3x 18 AWG, black external insulation, 300 V, 105°C, UL2517 cord, 310 ± 10 mm extension from grommet.	Live (L)	Brown
		Neutral (N)	Blue
		Protective Earth (PE)	Green Yellow
<b>DC Output</b>	12 V version: 6 x 14 AWG, Style 1015, 600 V, 105°C, 260±10 mm 24, 48 V versions: 4x 14 AWG, Style 1015, 600 V, 105°C, 260±10 mm	3x (2x) +V1 Output (+V1)	Red
		3x (2x) V1 Return (RTN)	Black
<b>Auxiliary Voltages Control Signals</b>	Wires: 8x 22 AWG, black external insulation, 300 V, 105°C, UL2517 cord, 220 ± 10 mm extension from grommet to connector.  Housed by Connector: Molex 90142-0008 Terminals: Molex 90119-0109 (Tin plating)  Mates with Molex 90130-1106 or equivalent. Terminals: Tin plating termination	+5 V Stand-by Output (+5V <sub>SB</sub> )	Red / 1
		Output Power Good (P_OK)	Green / 2
		- Fan Voltage (-V2)	Brown / 3
		Remote On/Off (PS_ON)	Grey / 4
		+ Terminal Remote Sense (+RS)	Yellow / 5
		Stand-by/Signals Return (RTN)	Blue / 6
		+ Fan Voltage (+V2)	White / 7
		Stand-by/Signals Return (RTN)	Black / 8

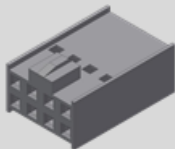



## 11. MECHANICAL SPECIFICATIONS

PARAMETER	DESCRIPTION / CONDITION
Weight	1300 g (2.87 lb) – without heatsink 1665 g (3.67 lb) – with heatsink
Overall Dimensions	83.0 x 212.0 x 42.0 mm (3.27 x 8.34 x 1.65 in) - without heatsink 83.0 x 212.0 x 70.1 mm (3.27 x 8.34 x 2.76 in) - with heatsink

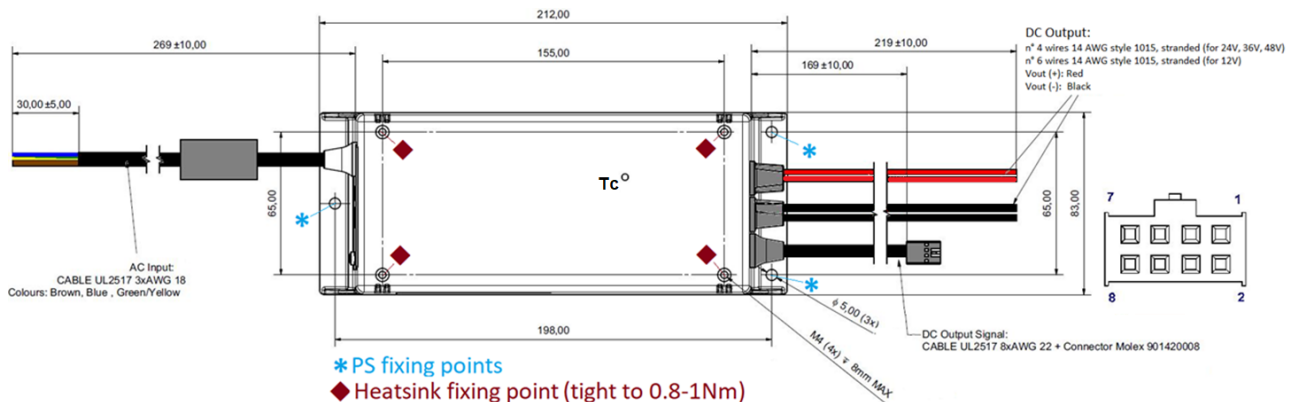
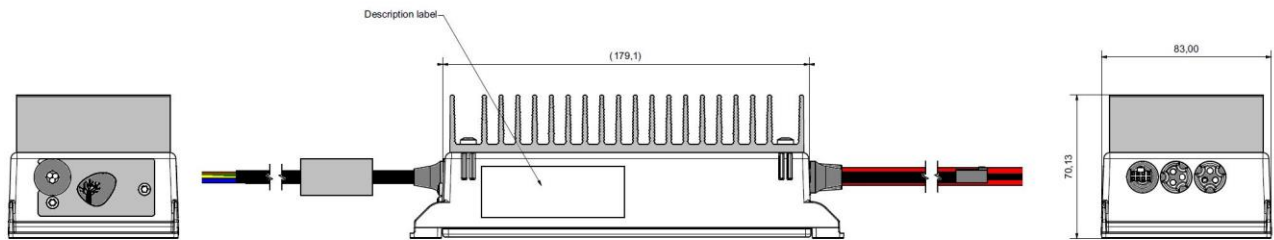
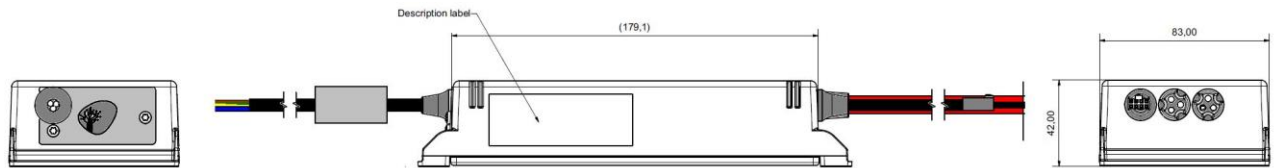

For more information on these products consult: [tech.support@psbel.com](mailto:tech.support@psbel.com)

**NUCLEAR AND MEDICAL APPLICATIONS** - Products are not designed or intended for use as critical components in life support systems, equipment used in hazardous environments, or nuclear control systems.

**TECHNICAL REVISIONS** - The appearance of products, including safety agency certifications pictured on labels, may change depending on the date manufactured. Specifications are subject to change without notice.



Asia-Pacific  
+86 755 298 85888

Europe, Middle East  
+353 61 225 977

North America  
+1 408 785 5200