

# YNV12T05 DC-DC Converter

9.6 - 14 VDC Input; 0.7525 - 5.5 VDC  
Programmable @ 5 A

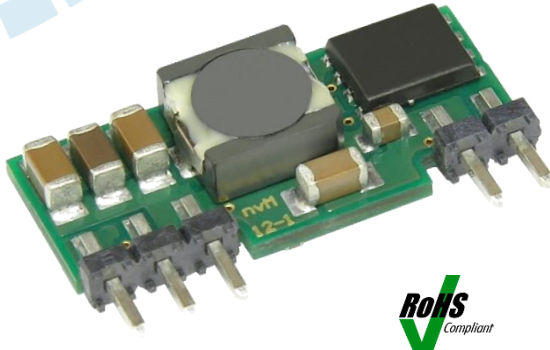

## Key Features & Benefits

- RoHS lead-free solder and lead-solder-exempted products are available
- Delivers up to 5 A (27.5 W)
- Industry-standard footprint and pinout
- Single-in-Line (SIP) Package:  
0.90" x 0.44" x 0.213"  
22.86 mm x 11.16 mm x 5.41 mm
- Weight: 0.07 oz [2.00 g]
- Synchronous Buck Converter Topology
- Start-up into pre-biased output
- No minimum load required
- Operating ambient temperature: -40 °C to 85 °C
- Remote ON/OFF
- Fixed-frequency operation
- Auto-reset output overcurrent protection
- Auto-reset overtemperature protection
- High reliability, MTBF approx. 71.8 million hours
- All materials meet UL94, V-0 flammability rating
- Approved to the latest edition and amendment of ITE Safety standards, UL/CSA 60950-1 and IEC60950-1

Bel Power Solutions point-of-load converters are recommended for use with regulated bus converters in an Intermediate Bus Architecture (IBA). The YNV12T05 non-isolated DC-DC converters deliver up to 5 A of output current in an industry-standard through-hole (SIP) package. The YNV12T05 converters operate from a 9.6 VDC–14 VDC input. These converters are ideal choices for Intermediate Bus Architectures where Point-of-Load power delivery is generally a requirement. They provide a resistor-programmable regulated output voltage of 0.7525 to 5.5 VDC.

The YNV12T05 converters provide exceptional thermal performance, even in high temperature environments with minimal airflow. This is accomplished through the use of circuit, packaging and processing techniques to achieve ultra-high efficiency, excellent thermal management, and a very sleek body profile.

The sleek body profile and the preclusion of heat sinks minimize impedance to system airflow, thus enhancing cooling for both upstream and downstream devices. The use of 100% automation for assembly, coupled with advanced power electronics and thermal design, results in a product with extremely high reliability.

## Applications

- Intermediate Bus Architectures
- Telecommunications
- Data Communications
- Distributed Power Architectures
- Servers, Workstations

## Benefits

- High Efficiency – no heat sink required
- Reduces Total Solution Board Area
- Minimizes Part Numbers in Inventory

### North America

+1-866.513.2839

### Asia-Pacific

+86.755.29885888

### Europe, Middle East

+353 61 225 977

tech.support@psbel.com  
[belpowersolutions.com](http://belpowersolutions.com)

# YNV12T05 DC-DC Converter

## Electrical Specifications

Conditions:  $T_A = 25\text{ }^\circ\text{C}$ , Airflow = 300 LFM (1 m/s),  $V_{in} = 12\text{ VDC}$ ,  $V_{out} = 0.7525 - 5.5\text{ VDC}$ , unless otherwise specified.

PARAMETER	NOTES	MIN	TYP	MAX	UNITS
<b>ABSOLUTE MAXIMUM RATINGS</b>					
Input Voltage	Continuous	-0.3		15	VDC
Operating Ambient Temperature		-40		85	$^\circ\text{C}$
Storage Temperature		-55		125	$^\circ\text{C}$
<b>FEATURE CHARACTERISTICS</b>					
Switching Frequency			480		kHz
Output Voltage Trim Range <sup>1</sup>	By external resistor, See Trim Table 1	0.7525		5.5	VDC
Remote Sense Compensation <sup>1</sup>	Percent of $V_{OUT(NOM)}$			0.5	VDC
Turn-On Delay Time <sup>2</sup>	Full resistive load				
With $V_{in}$ (Converter Enabled, then $V_{in}$ applied)	From $V_{in} = V_{in(min)}$ to $V_o = 0.1 * V_o(nom)$		6.5		ms
With Enable ( $V_{in} = V_{in(nom)}$ applied, then enabled)	From enable to $V_o = 0.1 * V_o(nom)$		6.5		ms
Rise time <sup>2</sup> (Full resistive load)	From $0.1 * V_o(nom)$ to $0.9 * V_o(nom)$		6.5		ms
ON/OFF Control (Negative Logic) <sup>3</sup>	Converter Off	2.4		$V_{in}$	VDC
	Converter On	-5		0.8	VDC
<b>INPUT CHARACTERISTICS</b>					
Operating Input Voltage Range		9.6	12	14	VDC
Input Under Voltage Lockout					
Turn-on Threshold			9.2		VDC
Turn-off Threshold			8.4		VDC
Maximum Input Current	5 ADC Out @ 9.6 VDC In				
	$V_{OUT} = 5.0\text{ VDC}$			2.9	ADC
	$V_{OUT} = 3.3\text{ VDC}$			2.0	ADC
	$V_{OUT} = 2.5\text{ VDC}$			1.6	ADC
	$V_{OUT} = 2.0\text{ VDC}$			1.3	ADC
	$V_{OUT} = 1.8\text{ VDC}$			1.2	ADC
	$V_{OUT} = 1.5\text{ VDC}$			1.0	ADC
	$V_{OUT} = 1.2\text{ VDC}$			0.85	ADC
	$V_{OUT} = 1.0\text{ VDC}$			0.75	ADC
	$V_{OUT} = 0.7525\text{ VDC}$			0.6	ADC
Input Stand-by Current (Converter disabled)			5		mA
Input No Load Current (Converter enabled)	$V_{OUT} = 5.0\text{ VDC}$		85		mA
	$V_{OUT} = 3.3\text{ VDC}$		65		mA
	$V_{OUT} = 2.5\text{ VDC}$		55		mA
	$V_{OUT} = 2.0\text{ VDC}$		45		mA
	$V_{OUT} = 1.8\text{ VDC}$		40		mA
	$V_{OUT} = 1.5\text{ VDC}$		35		mA
	$V_{OUT} = 1.2\text{ VDC}$		30		mA
	$V_{OUT} = 1.0\text{ VDC}$		25		mA
	$V_{OUT} = 0.7525\text{ VDC}$		20		mA
	Input Reflected-Ripple Current - $i_s$	See Fig. D for setup. (BW = 20 MHz)		10	

+1.866.513.2839

tech.support@psbel.com

[belpowersolutions.com](http://belpowersolutions.com)

# YNV12T05 DC-DC Converter

OUTPUT CHARACTERISTICS				
Output Voltage Set Point (no load)		-1.5	V <sub>out</sub>	+1.5 %V <sub>out</sub>
Output Regulation				
Over Line	Full resistive load @ 3.3 VDC		1	mV
Over Load	From no load to full load		0.25	%V <sub>out</sub>
Output Voltage Range	(Overall operating input voltage, resistive load and temperature conditions until end of life )	-2.5		+2.5 %V <sub>out</sub>
Output Ripple and Noise – 20 MHz bandwidth				
Peak-to-Peak	V <sub>OUT</sub> = 1.0 VDC		10	20 mV <sub>P-P</sub>
Peak-to-Peak	V <sub>OUT</sub> = 5.0 VDC		25	40 mV <sub>P-P</sub>
External Load Capacitance				
Min ESR > 1mΩ	Plus full load (resistive)			1,000 μF
Min ESR > 10 mΩ				2,000 μF
Output Current Range		0		5 ADC
Output Current Limit Inception (I <sub>OUT</sub> )			8.5	ADC
Output Short- Circuit Current , RMS Value	Short = 10 mΩ, continuous		2	Arms
DYNAMIC RESPONSE				
I <sub>out</sub> step from 2.5 A to 5 A with di/dt = 5 A/μs	Co = 47 μF tant. + 1 μF ceramic		120 <sup>1</sup>	mV
Settling Time (V <sub>OUT</sub> < 10% peak deviation)			60	μs
I <sub>out</sub> step change from 5 A to 2.5 A with di/dt = -5 A/μs	Co = 47 μF tant. + 1 μF ceramic		120 <sup>1</sup>	mV
Settling Time (V <sub>OUT</sub> < 10% peak deviation)			60	μs
EFFICIENCY				
	FULL LOAD (5 A)			
	V <sub>OUT</sub> = 5.0 VDC		90.0	%
	V <sub>OUT</sub> = 3.3 VDC		86.0	%
	V <sub>OUT</sub> = 2.5 VDC		83.0	%
	V <sub>OUT</sub> = 2.0 VDC		81.0	%
	V <sub>OUT</sub> = 1.8 VDC		80.0	%
	V <sub>OUT</sub> = 1.5 VDC		78.0	%
	V <sub>OUT</sub> = 1.2 VDC		75.5	%
	V <sub>OUT</sub> = 1.0 VDC		73.0	%
	V <sub>OUT</sub> = 0.7525 VDC		68.0	%

Notes:

- 1 The output voltage should not exceed 5.5V (taking into account both the programming and remote sense compensation).
- 2 Note that start-up time is the sum of turn-on delay time and rise time.
- 3 The converter is on if ON/OFF pin is left open.
- 4 See attached waveforms for dynamic response and settling time for different output voltages.

+1.866.513.2839  
 tech.support@psbel.com  
 belpowersolutions.com

# YNV12T05 DC-DC Converter

## Operations

### Input and Output Impedance

The Y-Series converter should be connected via a low impedance to the DC power source. In many applications, the inductance associated with the distribution from the power source to the input of the converter can affect the stability of the converter. It is recommended to use decoupling capacitors placed as close as possible to the converter's input pins in order to ensure stability of the converter and reduce input ripple voltage. Internally, the converter has 20  $\mu\text{F}$  (low ESR ceramics) of input capacitance.

In a typical application, low - ESR tantalum or POS capacitors will be sufficient to provide adequate ripple voltage filtering at the input of the converter. However, very low ESR ceramic capacitors 47 to 100  $\mu\text{F}$  are recommended at the input of the converter in order to minimize the input ripple voltage. They should be placed as close as possible to the input pins of the converter.

The YNV12T05 has been designed for stable operation with or without external capacitance. Low ESR ceramic capacitors placed as close as possible to the load (minimum 47  $\mu\text{F}$ ) are recommended for better transient performance and lower output voltage ripple.

It is important to keep low resistance and low inductance PCB traces for connecting load to the output pins of the converter in order to maintain good load regulation.

### ON/OFF (Pin 5)

The ON/OFF pin (Pin 5) is used to turn the converter on or off remotely via a system signal that is referenced to GND (Pin 3). Typical connections are shown in Fig. A.

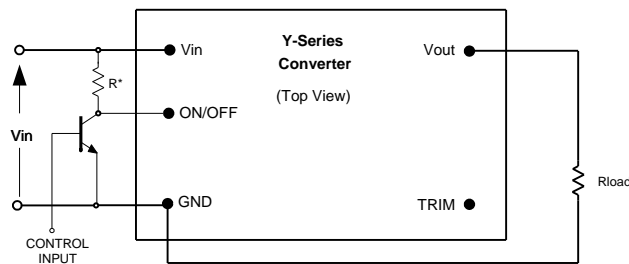

Fig. A: Circuit configuration for ON/OFF function.

To turn the converter on the ON/OFF pin should be at a logic low or left open, and to turn the converter off the ON/OFF pin should be at a logic high or connected to  $V_{in}$ .

The ON/OFF pin is internally pulled down. A TTL or CMOS logic gate, open-collector (open-drain) transistor can be used to drive ON/OFF pin. When using open collector (open-drain) transistor, add a pull-up resistor ( $R^*$ ) of 75  $\text{k}\Omega$  to  $V_{in}$  as shown in Fig. A. This device must be capable of:

- sinking up to 0.2 mA at a low level voltage of  $\leq 0.8 \text{ V}$
- sourcing up to 0.25 mA at a high logic level of 2.3 to 5 V
- sourcing up to 0.75 mA when connected to  $V_{in}$ .

### Output Voltage Programming (Pin 2)

The output voltage can be programmed from 0.7525 to 5.5 V by connecting an external resistor between the TRIM pin (Pin 2) and the GND pin (Pin 3); see Fig. B.

A trim resistor,  $R_{\text{TRIM}}$ , for a desired output voltage can be calculated using the following equation:

$$R_{\text{TRIM}} = \frac{10.5}{(V_{\text{O-REQ}} - 0.7525)} - 1 \quad [\text{k}\Omega]$$

where,

$R_{\text{TRIM}}$  = Required value of trim resistor [ $\text{k}\Omega$ ]

$V_{\text{O-REQ}}$  = Desired (trimmed) output voltage [V]

+1.866.513.2839  
tech.support@psbel.com  
belpowersolutions.com

# YNV12T05 DC-DC Converter

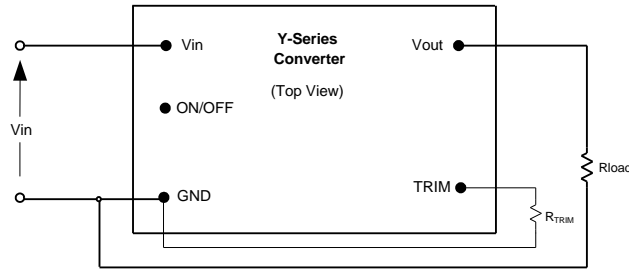

Fig. B: Configuration for programming output voltage.

Note that the tolerance of a trim resistor directly affects the output voltage tolerance. It is recommended to use standard 1% or 0.5% resistors; for tighter tolerance, two resistors in parallel are recommended rather than one standard value from Table 1.

The ground pin of the trim resistor should be connected directly to the converter's GND pin (Pin 3) with no voltage drop in between. Table 1 provides the trim resistor values for popular output voltages.

$V_{0-REG}$ [V]	$R_{TRIM}$ [k $\Omega$ ]	The Closest Standard Value [k $\Omega$ ]
0.7525	open	
1.0	41.42	41.2
1.2	22.46	22.6
1.5	13.05	13.0
1.8	9.02	9.09
2.0	7.42	7.50
2.5	5.01	4.99
3.3	3.12	3.09
5.0	1.47	1.47
5.5	1.21	1.21

Table 1: Trim Resistor Value

The output voltage can also be programmed by an external voltage source. To make trimming less sensitive, a series external resistor  $R_{EXT}$  is recommended between TRIM pin and programming voltage source. Control Voltage can be calculated by the formula:

$$V_{CTRL} = 0.7 - \frac{(1 + R_{EXT})(V_{O-REQ} - 0.7525)}{15} \quad [V]$$

where,

$V_{CTRL}$  = Control voltage [V]

$R_{EXT}$  = External resistor between TRIM pin and voltage source; the k $\Omega$  value can be chosen depending on the required output voltage range.

The control voltages with  $R_{EXT} = 0$  and  $R_{EXT} = 15$  k $\Omega$  are shown in Table 2.

$V_{0-REG}$ [V]	$V_{CTRL}$ ( $R_{EXT} = 0$ )	$V_{CTRL}$ ( $R_{EXT} = 15$ k $\Omega$ )
0.7525	0.700	0.700
1.0	0.684	0.436
1.2	0.670	0.223
1.5	0.650	-0.097
1.8	0.630	-0.417
2.0	0.617	-0.631
2.5	0.584	-1.164
3.3	0.530	-2.017
5.0	0.417	-3.831
5.5	0.384	-4.364

Table 2: Control Voltage [VDC]

+1.866.513.2839

tech.support@psbel.com

[belpowersolutions.com](http://belpowersolutions.com)

# YNV12T05 DC-DC Converter

## Protection Features

### Input Under-Voltage Lockout

Input under-voltage lockout is standard with this converter. The converter will shut down when the input voltage drops below a pre-determined voltage; it will start automatically when  $V_{in}$  returns to a specified range.

The input voltage must be typically 9.2 V for the converter to turn on. Once the converter has been turned on, it will shut off when the input voltage drops below typically 8.4 V.

### Output Overcurrent Protection (OCP)

The converter is protected against overcurrent and short circuit conditions. Upon sensing an overcurrent condition, the converter will enter hiccup mode. Once over-load or short circuit condition is removed,  $V_{out}$  will return to nominal value.

### Overtemperature Protection (OTP)

The converter will shut down under an overtemperature condition to protect itself from overheating caused by operation outside the thermal derating curves, or operation in abnormal conditions such as system fan failure. After the converter has cooled to a safe operating temperature, it will automatically restart.

## Safety Requirements

Approved to the latest edition and amendment of ITE Safety standards, UL/CSA 60950-1 and IEC60950-1.

The maximum DC voltage between any two pins is  $V_{in}$  under all operating conditions. Therefore, the unit has ELV (extra low voltage) output; it meets SELV requirements under the condition that all input voltages are ELV.

The converter is not internally fused. To comply with safety agencies requirements, a recognized fuse with a maximum rating of 7.5 Amps must be used in series with the input line.

## Characterization

### General Information

The converter has been characterized for many operational aspects, to include thermal derating (maximum load current as a function of ambient temperature and airflow) for vertical and horizontal mounting, efficiency, start-up and shutdown parameters, output ripple and noise, transient response to load step-change, overload, and short circuit.

The figures are numbered as Fig. x.y, where x indicates the different output voltages, and y associates with specific plots ( $y = 1$  for the vertical thermal derating, ...). For example, Fig. x.1 will refer to the vertical thermal derating for all the output voltages in general.

The following pages contain specific plots or waveforms associated with the converter. Additional comments for specific data are provided below.

### Test Conditions

All data presented were taken with the converter soldered to a test board, specifically a 0.060" thick printed wiring board (PWB) with four layers. The top and bottom layers were not metalized. The two inner layers, comprised of two-ounce copper, were used to provide traces for connectivity to the converter.

The lack of metalization on the outer layers as well as the limited thermal connection ensured that heat transfer from the converter to the PWB was minimized. This provides a worst-case but consistent scenario for thermal derating purposes.

All measurements requiring airflow were made in the vertical and horizontal wind tunnels using Infrared (IR) thermography and thermocouples for thermometry.

Ensuring components on the converter do not exceed their ratings is important to maintaining high reliability. If one anticipates operating the converter at or close to the maximum loads specified in the derating curves, it is prudent to check actual operating temperatures in the application. Thermographic imaging is preferable; if this capability is not available, then thermocouples may be used. The use of AWG #40 gauge thermocouples is recommended to ensure

+1.866.513.2839

tech.support@psbel.com

[belpowersolutions.com](http://belpowersolutions.com)

# YNV12T05 DC-DC Converter

measurement accuracy. Careful routing of the thermocouple leads will further minimize measurement error. Refer to Fig. C for optimum measuring thermocouple location.

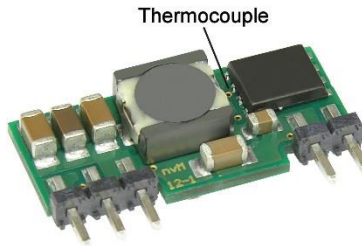

Fig. C: Location of the thermocouple for thermal testing.

## Thermal Derating

Load current vs. ambient temperature and airflow rates are given in Figs. x.1 to x.2 for maximum temperature of 120 °C. Ambient temperature was varied between 25 °C and 85 °C, with airflow rates from 30 to 500 LFM (0.15 to 2.5 m/s), and vertical and horizontal converter mounting. The airflow during the testing is parallel to the long axis of the converter, going from input pins to output pins.

For each set of conditions, the maximum load current is defined as the lowest of:

- (i) The output current at which any MOSFET temperature does not exceed a maximum specified temperature (120 °C) as indicated by the thermographic image, or
- (ii) The maximum current rating of the converter (5A)

During normal operation, derating curves with maximum FET temperature less than or equal to 120 °C should not be exceeded. Temperature on the PCB at the thermocouple location shown in Fig. C should not exceed 120 °C in order to operate inside the derating curves.

## Efficiency

Figure x.3 shows the efficiency vs. load current plot for ambient temperature of 25 °C, airflow rate of 200 LFM (1 m/s) and input voltages of 9.6 V, 12 V, and 14 V.

## Power Dissipation

Fig. x.4 shows the power dissipation vs. load current plot for  $T_a = 25\text{ °C}$ , airflow rate of 200 LFM (1 m/s) with vertical mounting and input voltages of 9.6 V, 12 V, and 14 V.

## Ripple and Noise

The output voltage ripple waveform is measured at full rated load current. Note that all output voltage waveforms are measured across a 1  $\mu\text{F}$  ceramic capacitor. The output voltage ripple and input reflected ripple current waveforms are obtained using the test setup shown in Fig. D.

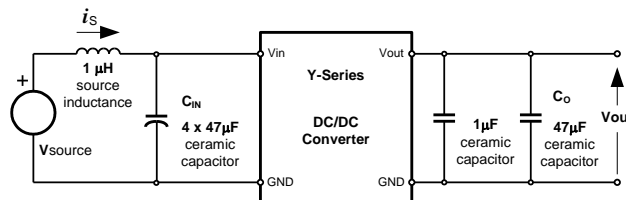

Fig. D: Test Set-up for measuring input reflected ripple currents,  $i_s$  and output voltage ripple

+1.866.513.2839  
tech.support@psbel.com  
[belpowersolutions.com](http://belpowersolutions.com)

# YNV12T05 DC-DC Converter

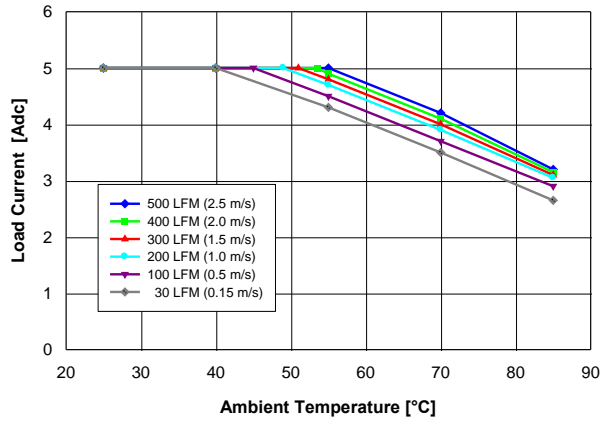

Fig. 5.0V.1: Available load current vs. ambient temperature and airflow rates for  $V_{out} = 5.0\text{ V}$  converter mounted vertically with  $V_{in} = 12\text{ V}$ , and maximum MOSFET temperature  $\leq 120\text{ }^{\circ}\text{C}$ .

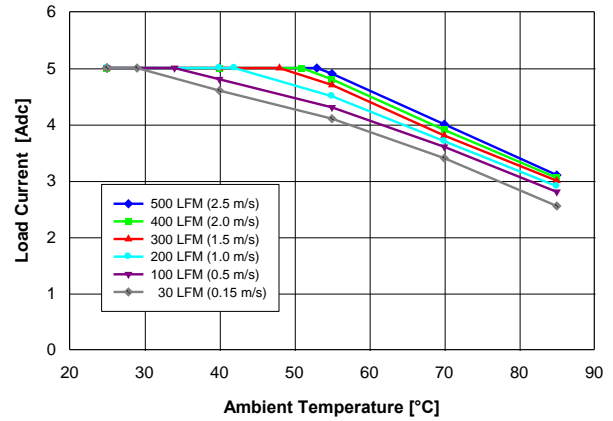

Fig. 5.0V.2: Available load current vs. ambient temperature and airflow rates for  $V_{out} = 5.0\text{ V}$  converter mounted horizontally with  $V_{in} = 12\text{ V}$ , and maximum MOSFET temperature  $\leq 120\text{ }^{\circ}\text{C}$ .

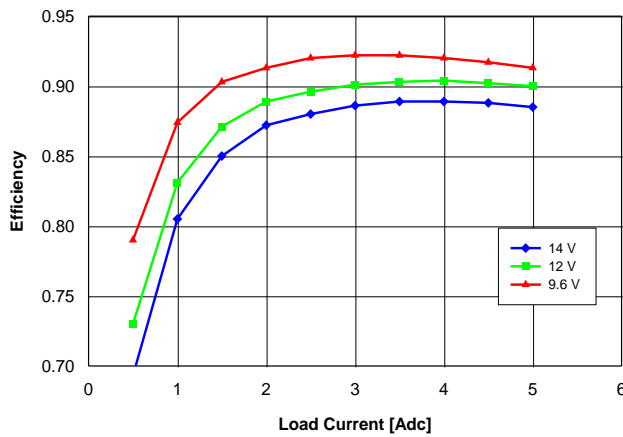

Fig. 5.0V.3: Efficiency vs. load current and input voltage for  $V_{out} = 5.0\text{ V}$  converter mounted vertically with air flowing at a rate of 200 LFM (1 m/s) and  $T_a = 25\text{ }^{\circ}\text{C}$ .

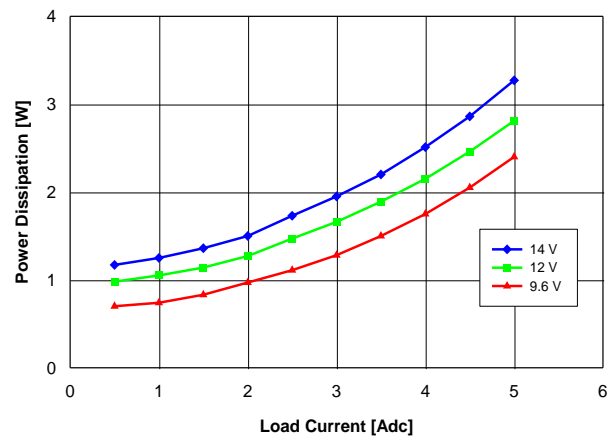

Fig. 5.0V.4: Power Loss vs. load current and input voltage for  $V_{out} = 5.0\text{ V}$  converter mounted vertically with air flowing at a rate of 200 LFM (1 m/s) and  $T_a = 25\text{ }^{\circ}\text{C}$ .

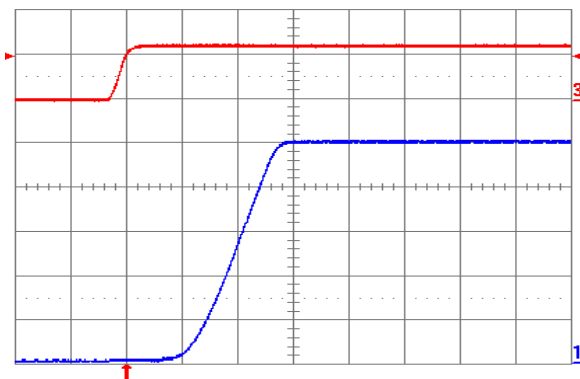

Fig. 5.0V.5: Turn-on transient for  $V_{out} = 5.0\text{ V}$  with application of  $V_{in}$  at full rated load current (resistive) and  $100\text{ }\mu\text{F}$  external capacitance at  $V_{in} = 12\text{ V}$ . Top trace:  $V_{in}$  (10 V/div.); Bottom trace: output voltage (1 V/div.); Time scale: 5 ms/div.

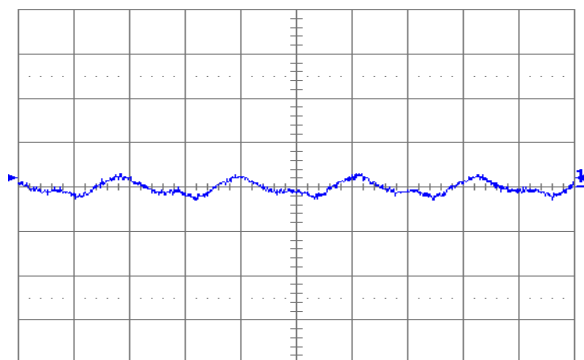

Fig. 5.0V.6: Output voltage ripple (20 mV/div.) at full rated load current into a resistive load with external capacitance  $100\text{ }\mu\text{F}$  ceramic and  $V_{in} = 12\text{ V}$  for  $V_{out} = 5.0\text{ V}$ . Time scale: 1  $\mu\text{s}$ /div.



# YNV12T05 DC-DC Converter

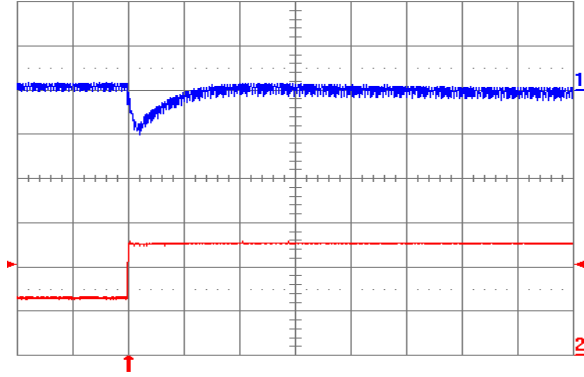

Fig. 5.0V.7: Output voltage response for  $V_{out} = 5.0\text{ V}$  to positive load current step change from 2.5 A to 5 A with slew rate of  $5\text{ A}/\mu\text{s}$  at  $V_{in} = 12\text{ V}$ . Top trace: output voltage (100 mV/div.); Bottom trace: load current (2 A/div.).  $C_o = 100\text{ }\mu\text{F}$  ceramic. Time scale:  $20\text{ }\mu\text{s}/\text{div}$ .

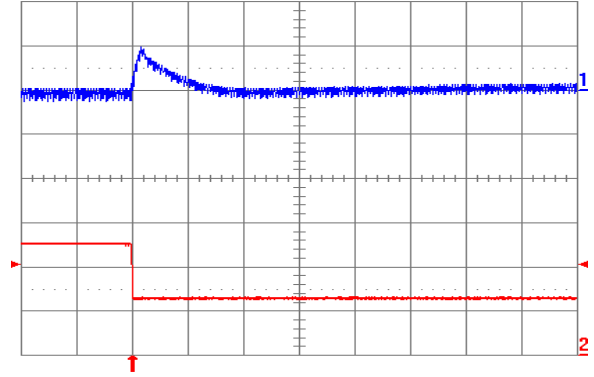

Fig. 5.0V.8: Output voltage response for  $V_{out} = 5.0\text{ V}$  to negative load current step change from 5 A to 2.5 A with slew rate of  $-5\text{ A}/\mu\text{s}$  at  $V_{in} = 12\text{ V}$ . Top trace: output voltage (100 mV/div.); Bottom trace: load current (2 A/div.).  $C_o = 100\text{ }\mu\text{F}$  ceramic. Time scale:  $20\text{ }\mu\text{s}/\text{div}$ .

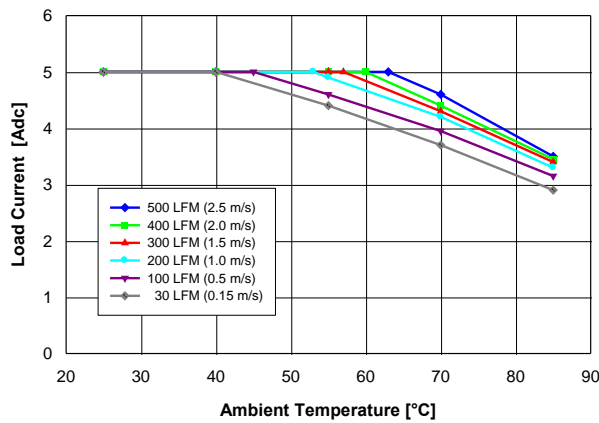

Fig. 3.3V.1: Available load current vs. ambient temperature and airflow rates for  $V_{out} = 3.3\text{ V}$  converter mounted vertically with  $V_{in} = 12\text{ V}$ , and maximum MOSFET temperature  $\leq 120\text{ }^\circ\text{C}$ .

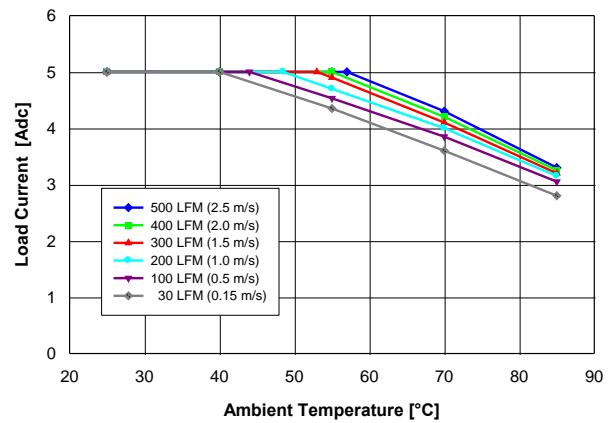

Fig. 3.3V.2: Available load current vs. ambient temperature and airflow rates for  $V_{out} = 3.3\text{ V}$  converter mounted horizontally with  $V_{in} = 12\text{ V}$ , and maximum MOSFET temperature  $\leq 120\text{ }^\circ\text{C}$ .

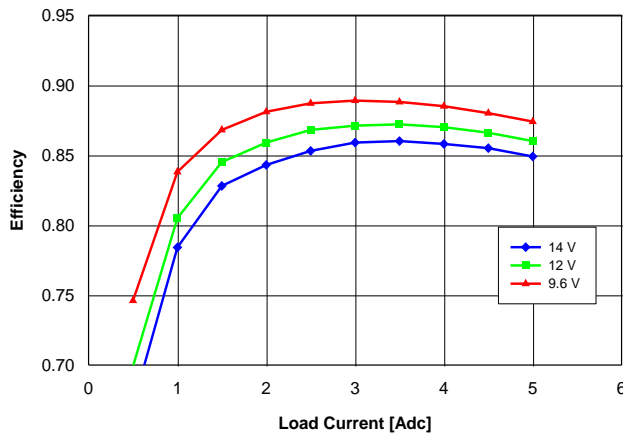

Fig. 3.3V.3: Efficiency vs. load current and input voltage for  $V_{out} = 3.3\text{ V}$  converter mounted vertically with air flowing at a rate of 200 LFM (1 m/s) and  $T_a = 25\text{ }^\circ\text{C}$ .

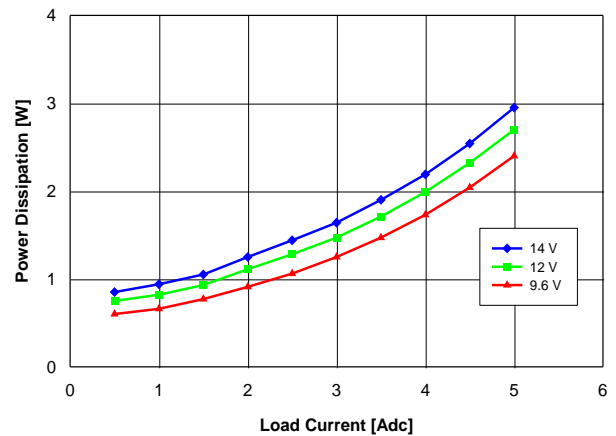

Fig. 3.3V.4: Power Loss vs. load current and input voltage for  $V_{out} = 3.3\text{ V}$  converter mounted vertically with air flowing at a rate of 200 LFM (1 m/s) and  $T_a = 25\text{ }^\circ\text{C}$ .

# YNV12T05 DC-DC Converter

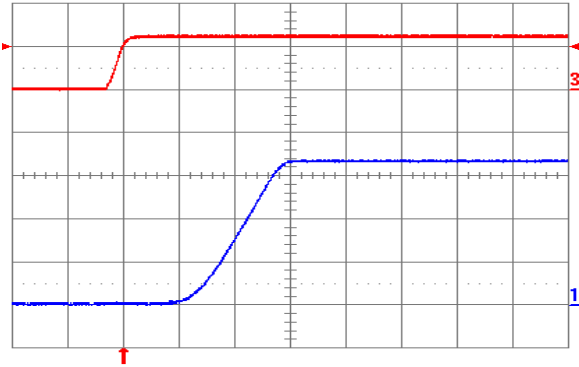

Fig. 3.3V.5: Turn-on transient for  $V_{out} = 3.3\text{ V}$  with application of  $V_{in}$  at full rated load current (resistive) and  $100\ \mu\text{F}$  external capacitance at  $V_{in} = 12\text{ V}$ . Top trace:  $V_{in}$  (10 V/div.); Bottom trace: output voltage (1 V/div.); Time scale: 5 ms/div.

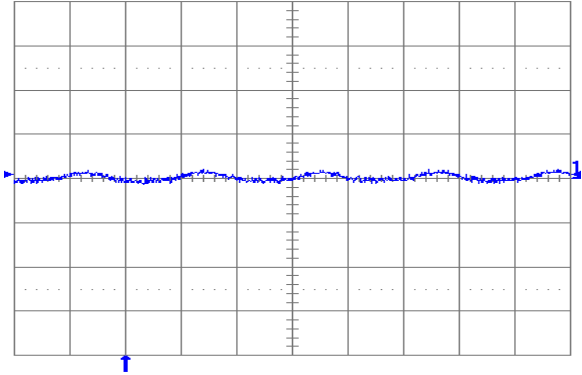

Fig. 3.3V.6: Output voltage ripple (20 mV/div.) at full rated load current into a resistive load with external capacitance  $100\ \mu\text{F}$  ceramic and  $V_{in} = 12\text{ V}$  for  $V_{out} = 3.3\text{ V}$ . Time scale:  $1\ \mu\text{s}/\text{div}$ .

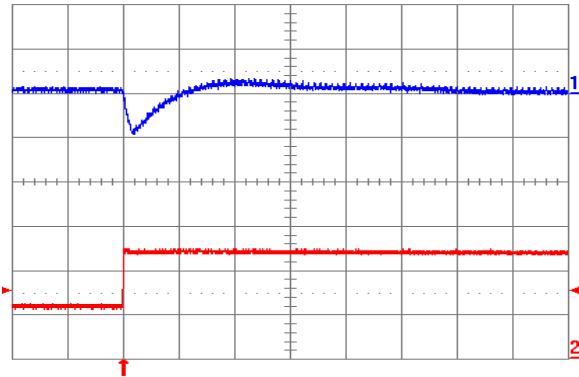

Fig. 3.3V.7: Output voltage response for  $V_{out} = 3.3\text{ V}$  to positive load current step change from 2.5 A to 5 A with slew rate of  $5\text{ A}/\mu\text{s}$  at  $V_{in} = 12\text{ V}$ . Top trace: output voltage (100 mV/div.); Bottom trace: load current (2 A/div.).  $C_o = 100\ \mu\text{F}$  ceramic. Time scale:  $20\ \mu\text{s}/\text{div}$ .

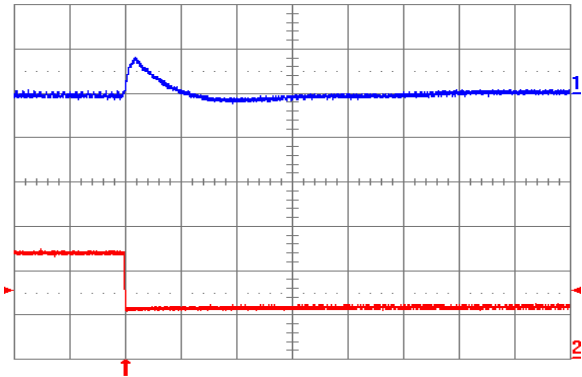

Fig. 3.3V.8: Output voltage response for  $V_{out} = 3.3\text{ V}$  to negative load current step change from 5 A to 2.5 A with slew rate of  $-5\text{ A}/\mu\text{s}$  at  $V_{in} = 12\text{ V}$ . Top trace: output voltage (100 mV/div.); Bottom trace: load current (2 A/div.).  $C_o = 100\ \mu\text{F}$  ceramic. Time scale:  $20\ \mu\text{s}/\text{div}$ .

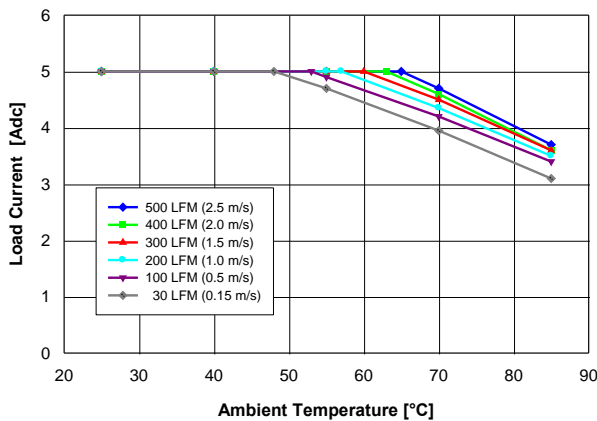

Fig. 2.5V.1: Available load current vs. ambient temperature and airflow rates for  $V_{out} = 2.5\text{ V}$  converter mounted vertically with  $V_{in} = 12\text{ V}$ , and maximum MOSFET temperature  $\leq 120\text{ }^\circ\text{C}$ .

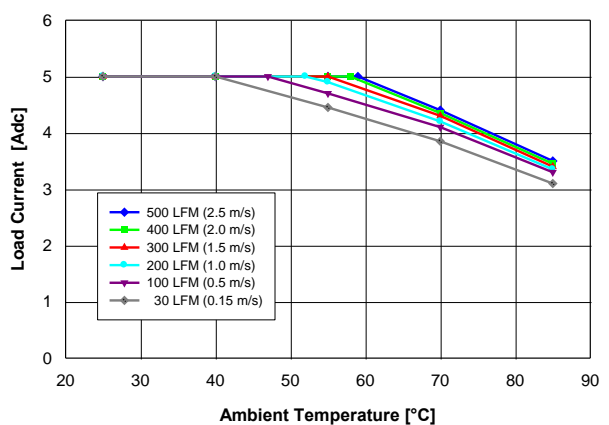

Fig. 2.5V.2: Available load current vs. ambient temperature and airflow rates for  $V_{out} = 2.5\text{ V}$  converter mounted horizontally with  $V_{in} = 12\text{ V}$ , and maximum MOSFET temperature  $\leq 120\text{ }^\circ\text{C}$ .

+1.866.513.2839

tech.support@psbel.com

belpowersolutions.com

# YNV12T05 DC-DC Converter

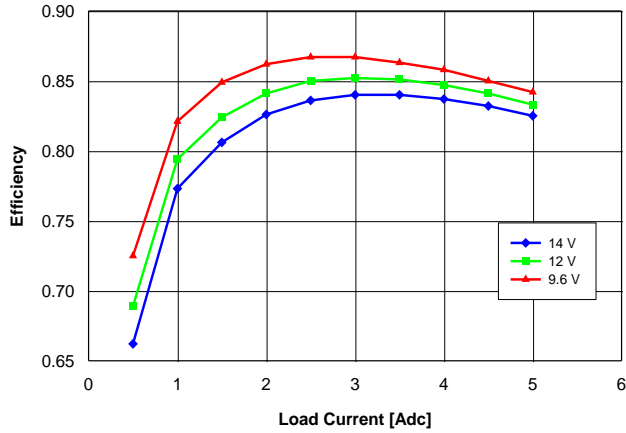

Fig. 2.5V.3: Efficiency vs. load current and input voltage for  $V_{out} = 2.5\text{ V}$  converter mounted vertically with air flowing at a rate of 200 LFM (1 m/s) and  $T_a = 25\text{ }^\circ\text{C}$ .

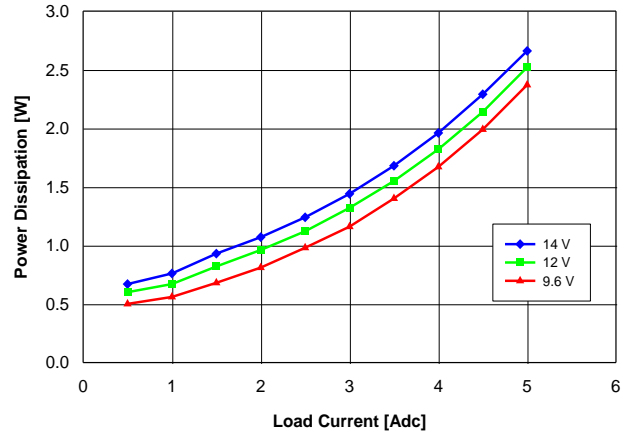

Fig. 2.5V.4: Power Loss vs. load current and input voltage for  $V_{out} = 2.5\text{ V}$  converter mounted vertically with air flowing at a rate of 200 LFM (1 m/s) and  $T_a = 25\text{ }^\circ\text{C}$ .

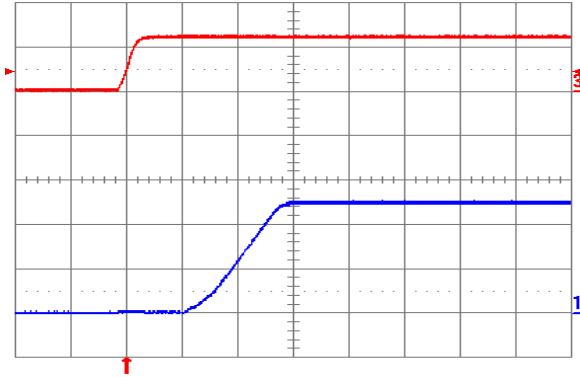

Fig. 2.5V.5: Turn-on transient for  $V_{out} = 2.5\text{ V}$  with application of  $V_{in}$  at full rated load current (resistive) and  $100\text{ }\mu\text{F}$  external capacitance at  $V_{in} = 12\text{ V}$ . Top trace:  $V_{in}$  (10 V/div.); Bottom trace: output voltage (1 V/div.); Time scale: 5 ms/div.

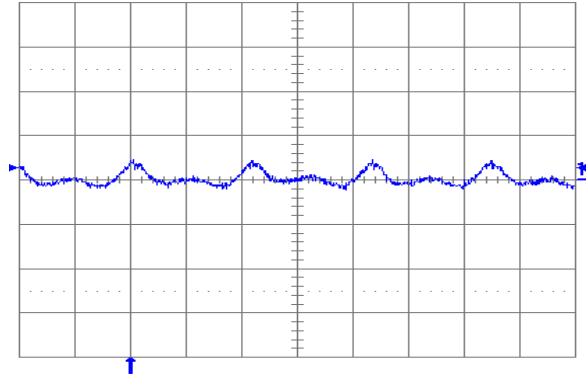

Fig. 2.5V.6: Output voltage ripple (20 mV/div.) at full rated load current into a resistive load with external capacitance  $100\text{ }\mu\text{F}$  ceramic +  $1\text{ }\mu\text{F}$  ceramic and  $V_{in} = 12\text{ V}$  for  $V_{out} = 2.5\text{ V}$ . Time scale: 2  $\mu\text{s}$ /div.

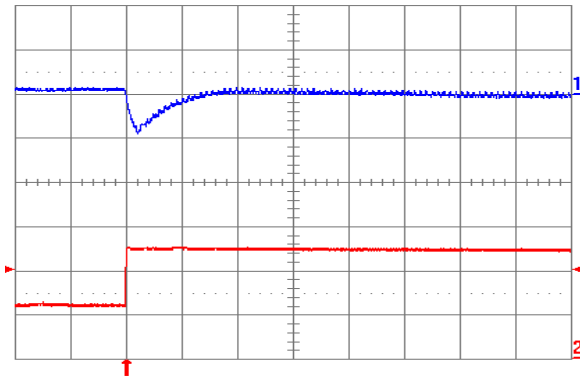

Fig. 2.5V.7: Output voltage response for  $V_{out} = 2.5\text{ V}$  to positive load current step change from 2.5 A to 5 A with slew rate of  $5\text{ A}/\mu\text{s}$  at  $V_{in} = 12\text{ V}$ . Top trace: output voltage (100 mV/div.); Bottom trace: load current (2 A/div.).  $C_o = 100\text{ }\mu\text{F}$  ceramic. Time scale: 20  $\mu\text{s}$ /div.

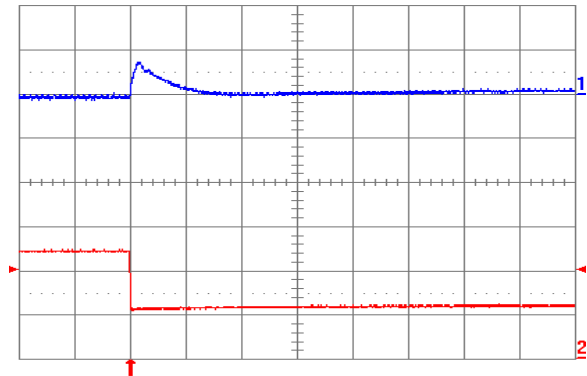

Fig. 2.5V.8: Output voltage response for  $V_{out} = 2.5\text{ V}$  to negative load current step change from 5 A to 2.5 A with slew rate of  $-5\text{ A}/\mu\text{s}$  at  $V_{in} = 12\text{ V}$ . Top trace: output voltage (100 mV/div.); Bottom trace: load current (2 A/div.).  $C_o = 100\text{ }\mu\text{F}$  ceramic. Time scale: 20  $\mu\text{s}$ /div.

+1.866.513.2839

tech.support@psbel.com

belpowersolutions.com

# YNV12T05 DC-DC Converter

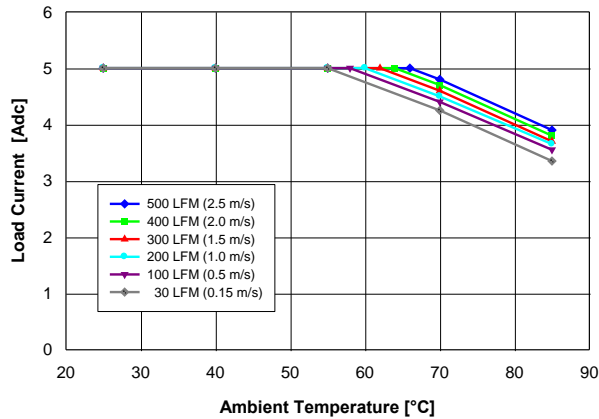

Fig. 2.0V.1: Available load current vs. ambient temperature and airflow rates for  $V_{out} = 2.0\text{ V}$  converter mounted vertically with  $V_{in} = 12\text{ V}$ , and maximum MOSFET temperature  $\leq 120\text{ }^{\circ}\text{C}$ .

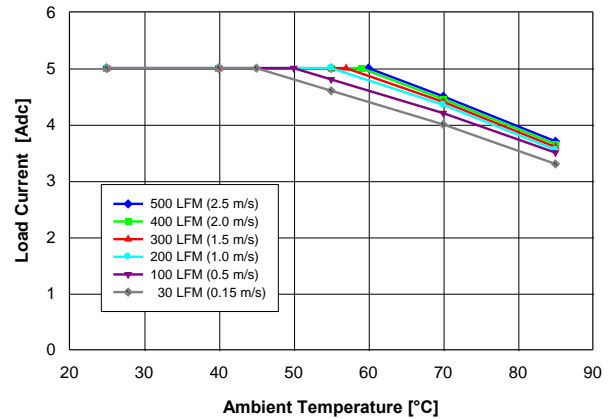

Fig. 2.0V.2: Available load current vs. ambient temperature and airflow rates for  $V_{out} = 2.0\text{ V}$  converter mounted horizontally with  $V_{in} = 12\text{ V}$ , and maximum MOSFET temperature  $\leq 120\text{ }^{\circ}\text{C}$ .

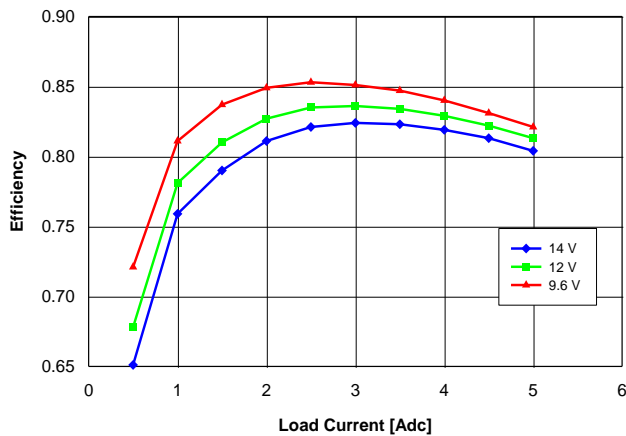

Fig. 2.0V.3: Efficiency vs. load current and input voltage for  $V_{out} = 2.0\text{ V}$  converter mounted vertically with air flowing at a rate of 200 LFM (1 m/s) and  $T_a = 25\text{ }^{\circ}\text{C}$ .

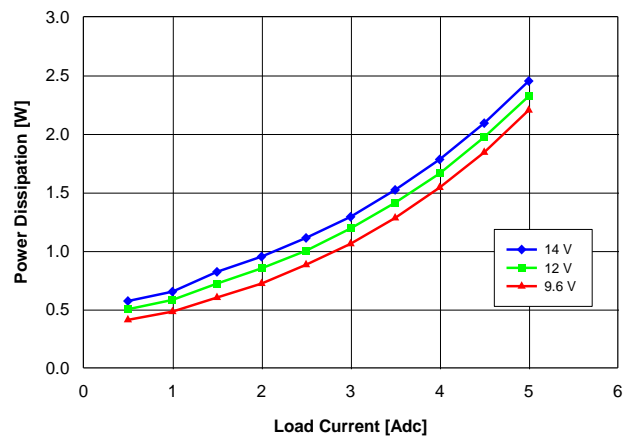

Fig. 2.0V.4: Power Loss vs. load current and input voltage for  $V_{out} = 2.0\text{ V}$  converter mounted vertically with air flowing at a rate of 200 LFM (1 m/s) and  $T_a = 25\text{ }^{\circ}\text{C}$ .

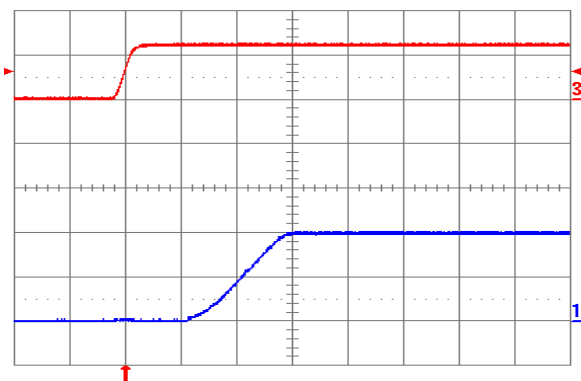

Fig. 2.0V.5: Turn-on transient for  $V_{out} = 2.0\text{ V}$  with application of  $V_{in}$  at full rated load current (resistive) and  $100\text{ }\mu\text{F}$  external capacitance at  $V_{in} = 12\text{ V}$ . Top trace:  $V_{in}$  (10 V/div.); Bottom trace: output voltage (1 V/div.); Time scale: 5 ms/div.

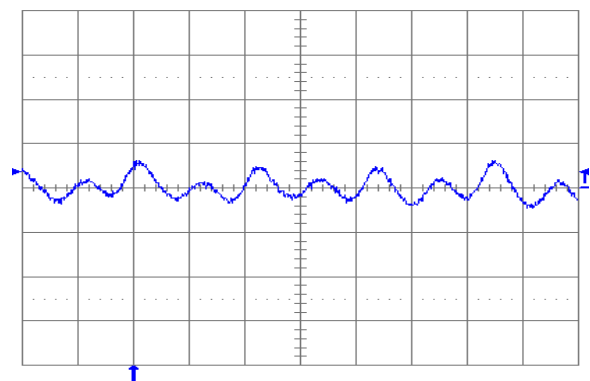

Fig. 2.0V.6: Output voltage ripple (20 mV/div.) at full rated load current into a resistive load with external capacitance  $100\text{ }\mu\text{F}$  ceramic and  $V_{in} = 12\text{ V}$  for  $V_{out} = 2.0\text{ V}$ . Time scale: 1  $\mu\text{s}$ /div.

# YNV12T05 DC-DC Converter

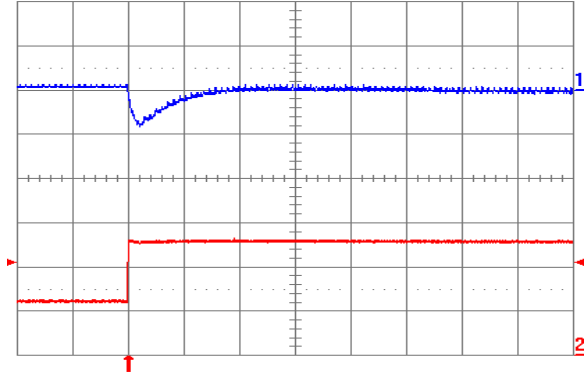

Fig. 2.0V.7: Output voltage response for  $V_{out} = 2.0\text{ V}$  to positive load current step change from 2.5 A to 5 A with slew rate of  $5\text{ A}/\mu\text{s}$  at  $V_{in} = 12\text{ V}$ . Top trace: output voltage (100 mV/div.); Bottom trace: load current (2 A/div.).  $C_o = 100\text{ }\mu\text{F}$  ceramic. Time scale:  $20\text{ }\mu\text{s}/\text{div}$ .

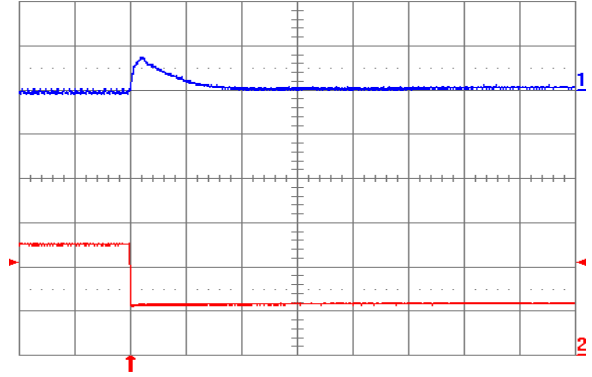

Fig. 2.0V.8: Output voltage response for  $V_{out} = 2.0\text{ V}$  to negative load current step change from 5 A to 2.5 A with slew rate of  $-5\text{ A}/\mu\text{s}$  at  $V_{in} = 12\text{ V}$ . Top trace: output voltage (100 mV/div.); Bottom trace: load current (2 A/div.).  $C_o = 100\text{ }\mu\text{F}$  ceramic. Time scale:  $20\text{ }\mu\text{s}/\text{div}$ .

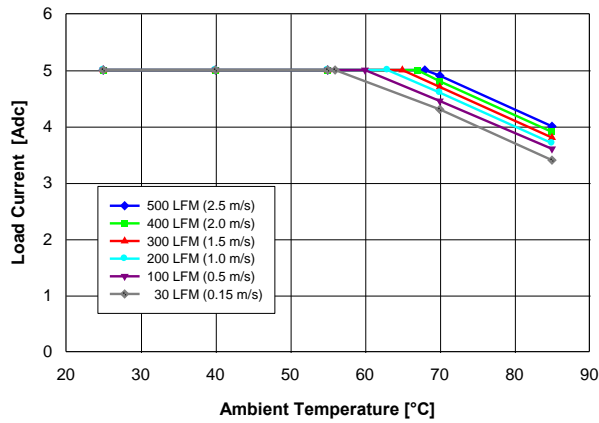

Fig. 1.8V.1: Available load current vs. ambient temperature and airflow rates for  $V_{out} = 1.8\text{ V}$  converter mounted vertically with  $V_{in} = 12\text{ V}$ , and maximum MOSFET temperature  $\leq 120\text{ }^\circ\text{C}$ .

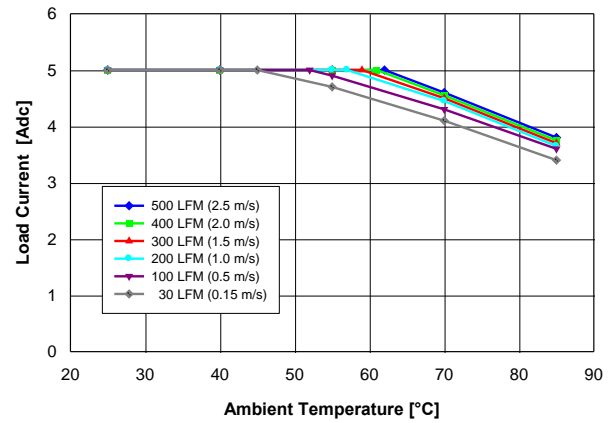

Fig. 1.8V.2: Available load current vs. ambient temperature and airflow rates for  $V_{out} = 1.8\text{ V}$  converter mounted horizontally with  $V_{in} = 12\text{ V}$ , and maximum MOSFET temperature  $\leq 120\text{ }^\circ\text{C}$ .

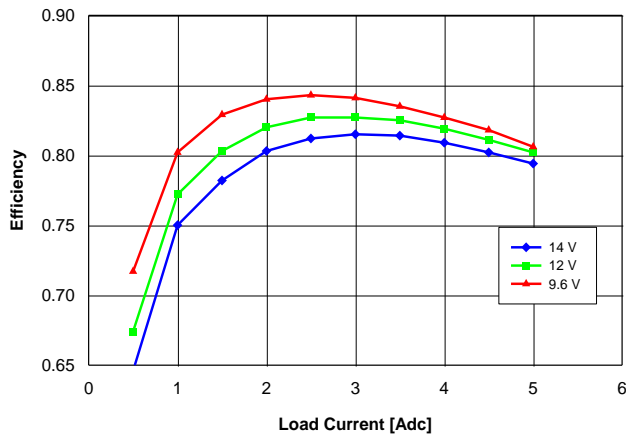

Fig. 1.8V.3: Efficiency vs. load current and input voltage for  $V_{out} = 1.8\text{ V}$  converter mounted vertically with air flowing at a rate of 200 LFM (1 m/s) and  $T_a = 25\text{ }^\circ\text{C}$

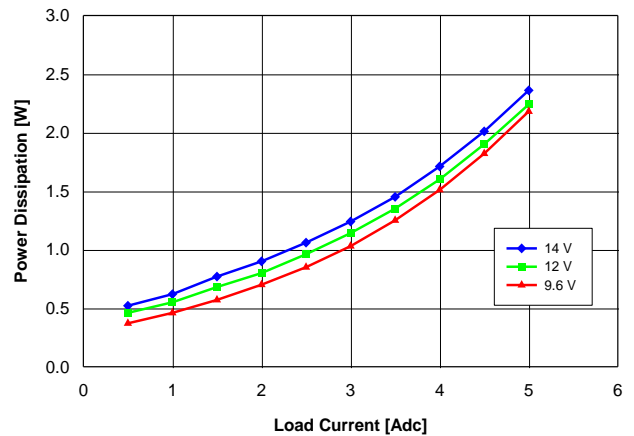

Fig. 1.8V.4: Power Loss vs. load current and input voltage for  $V_{out} = 1.8\text{ V}$  converter mounted vertically with air flowing at a rate of 200 LFM (1 m/s) and  $T_a = 25\text{ }^\circ\text{C}$

# YNV12T05 DC-DC Converter

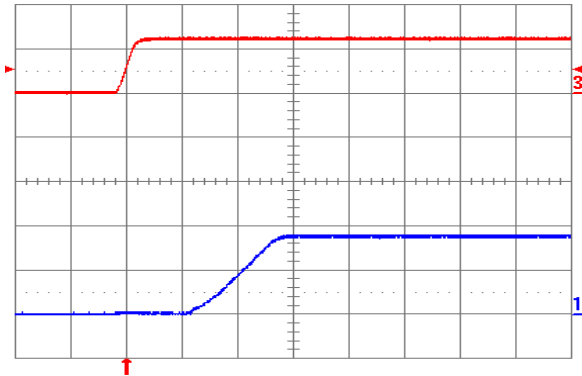

Fig. 1.8V.5: Turn-on transient for  $V_{out} = 1.8\text{ V}$  with application of  $V_{in}$  at full rated load current (resistive) and  $100\ \mu\text{F}$  external capacitance at  $V_{in} = 12\text{ V}$ . Top trace:  $V_{in}$  ( $10\text{ V/div.}$ ); Bottom trace: output voltage ( $1\text{ V/div.}$ ); Time scale:  $5\text{ ms/div.}$

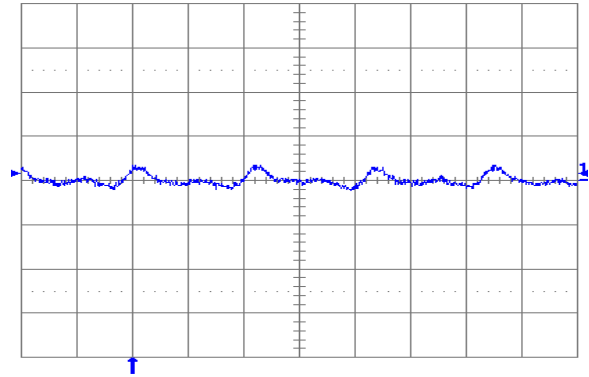

Fig. 1.8V.6: Output voltage ripple ( $20\text{ mV/div.}$ ) at full rated load current into a resistive load with external capacitance  $100\ \mu\text{F}$  ceramic and  $V_{in} = 12\text{ V}$  for  $V_{out} = 1.8\text{ V}$ . Time scale:  $1\ \mu\text{s/div.}$

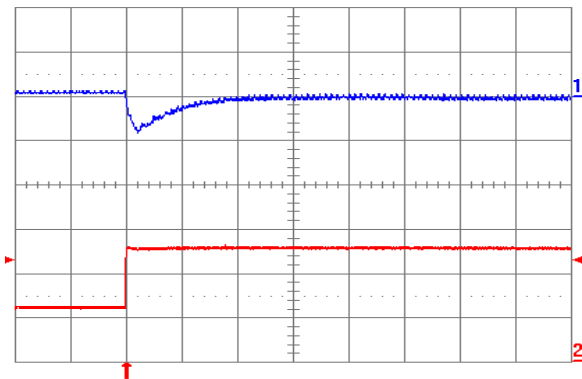

Fig. 1.8V.7: Output voltage response for  $V_{out} = 1.8\text{ V}$  to positive load current step change from  $2.5\text{ A}$  to  $5\text{ A}$  with slew rate of  $5\text{ A}/\mu\text{s}$  at  $V_{in} = 12\text{ V}$ . Top trace: output voltage ( $100\text{ mV/div.}$ ); Bottom trace: load current ( $2\text{ A/div.}$ ).  $C_o = 100\ \mu\text{F}$  ceramic. Time scale:  $20\ \mu\text{s/div.}$

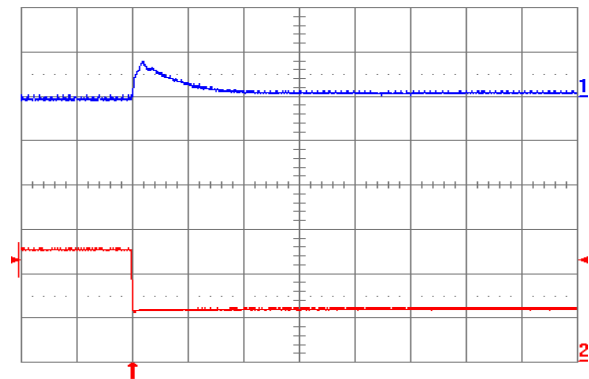

Fig. 1.8V.8: Output voltage response for  $V_{out} = 1.8\text{ V}$  to negative load current step change from  $5\text{ A}$  to  $2.5\text{ A}$  with slew rate of  $-5\text{ A}/\mu\text{s}$  at  $V_{in} = 12\text{ V}$ . Top trace: output voltage ( $100\text{ mV/div.}$ ); Bottom trace: load current ( $2\text{ A/div.}$ ).  $C_o = 100\ \mu\text{F}$  ceramic. Time scale:  $20\ \mu\text{s/div.}$

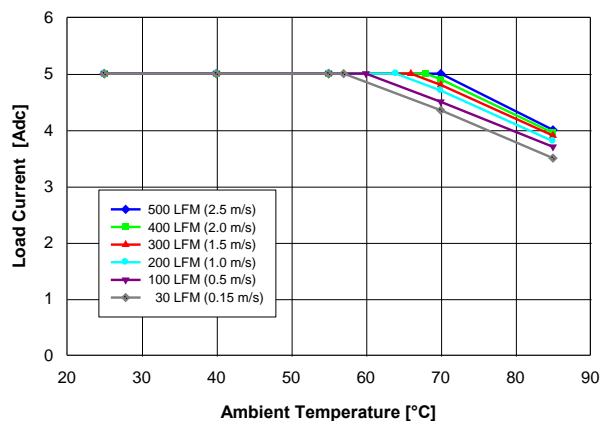

Fig. 1.5V.1: Available load current vs. ambient temperature and airflow rates for  $V_{out} = 1.5\text{ V}$  converter mounted vertically with  $V_{in} = 12\text{ V}$ , and maximum MOSFET temperature  $\leq 120\text{ }^\circ\text{C}$ .

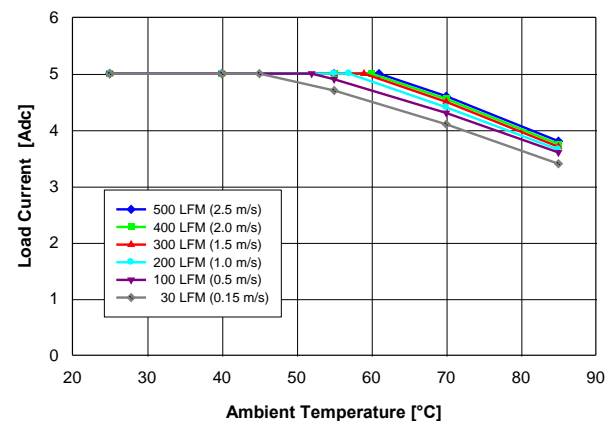

Fig. 1.5V.2: Available load current vs. ambient temperature and airflow rates for  $V_{out} = 1.5\text{ V}$  converter mounted horizontally with  $V_{in} = 12\text{ V}$ , and maximum MOSFET temperature  $\leq 120\text{ }^\circ\text{C}$ .

# YNV12T05 DC-DC Converter

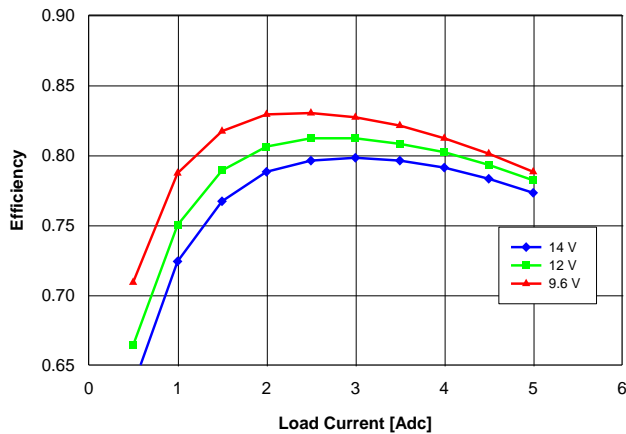

Fig. 1.5V.3: Efficiency vs. load current and input voltage for  $V_{out} = 1.5$  V converter mounted vertically with air flowing at a rate of 200 LFM (1 m/s) and  $T_a = 25$  °C.

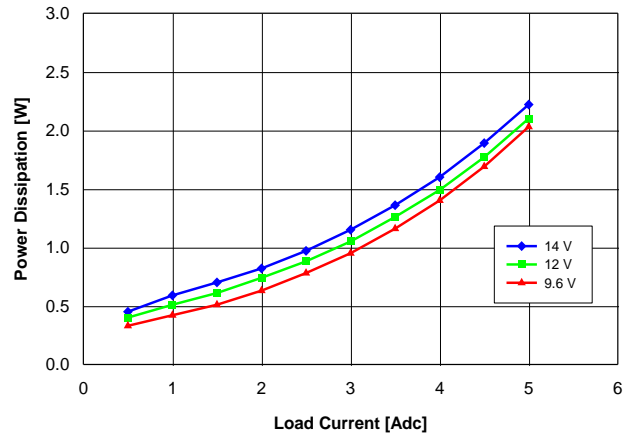

Fig. 1.5V.4: Power Loss vs. load current and input voltage for  $V_{out} = 1.5$  V converter mounted vertically with air flowing at a rate of 200 LFM (1 m/s) and  $T_a = 25$  °C

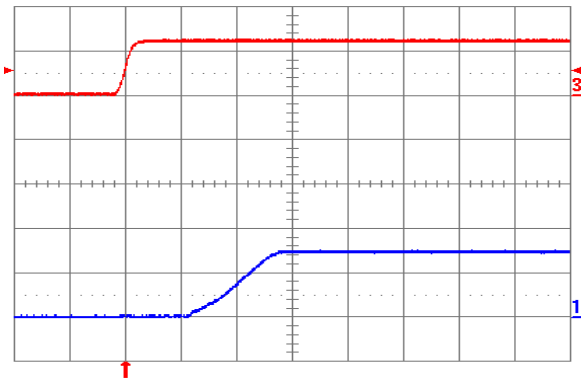

Fig. 1.5V.5: Turn-on transient for  $V_{out} = 1.5$  V with application of  $V_{in}$  at full rated load current (resistive) and 100  $\mu$ F external capacitance at  $V_{in} = 12$  V. Top trace:  $V_{in}$  (10 V/div.); Bottom trace: output voltage (1 V/div.); Time scale: 5 ms/div.

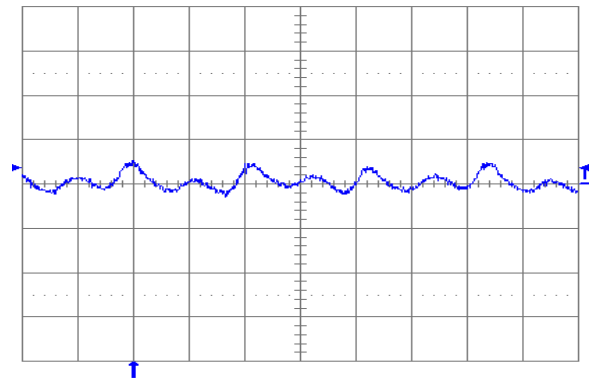

Fig. 1.5V.6: Output voltage ripple (20 mV/div.) at full rated load current into a resistive load with external capacitance 100  $\mu$ F ceramic and  $V_{in} = 12$  V for  $V_{out} = 1.5$  V. Time scale: 1  $\mu$ s/div.

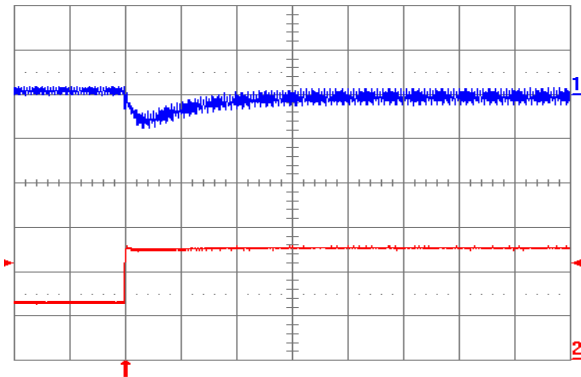

Fig. 1.5V.7: Output voltage response for  $V_{out} = 1.5$  V to positive load current step change from 2.5 A to 5 A with slew rate of 5 A/ $\mu$ s at  $V_{in} = 12$  V. Top trace: output voltage (100 mV/div.); Bottom trace: load current (2 A/div.).  $C_o = 100$   $\mu$ F ceramic. Time scale: 20  $\mu$ s/div.

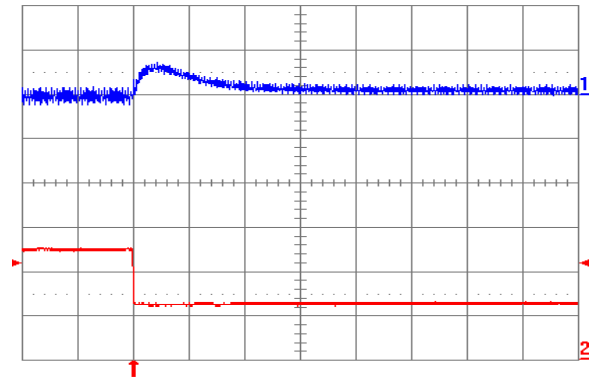

Fig. 1.5V.8: Output voltage response for  $V_{out} = 1.5$  V to negative load current step change from 5 A to 2.5 A with slew rate of -5 A/ $\mu$ s at  $V_{in} = 12$  V. Top trace: output voltage (100 mV/div.); Bottom trace: load current (2 A/div.).  $C_o = 100$   $\mu$ F ceramic. Time scale: 20  $\mu$ s/div

+1.866.513.2839

tech.support@psbel.com

belpowersolutions.com

# YNV12T05 DC-DC Converter

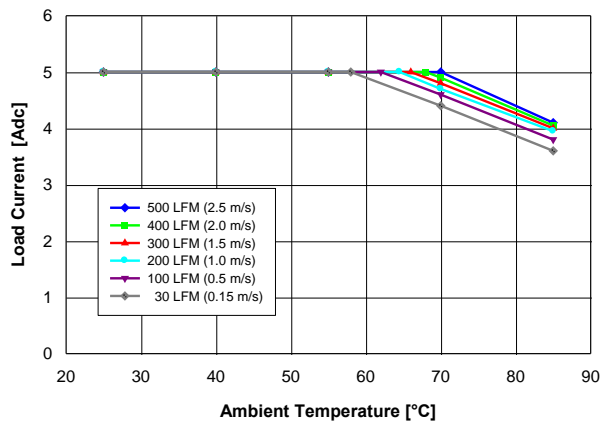

Fig. 1.2V.1: Available load current vs. ambient temperature and airflow rates for  $V_{out} = 1.2\text{ V}$  converter mounted vertically with  $V_{in} = 12\text{ V}$ , and maximum MOSFET temperature  $\leq 120\text{ }^{\circ}\text{C}$ .

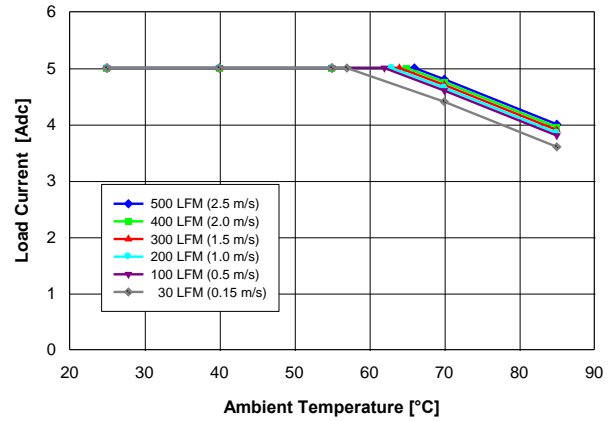

Fig. 1.2V.2: Available load current vs. ambient temperature and airflow rates for  $V_{out} = 1.2\text{ V}$  converter mounted horizontally with  $V_{in} = 12\text{ V}$ , and maximum MOSFET temperature  $\leq 120\text{ }^{\circ}\text{C}$ .

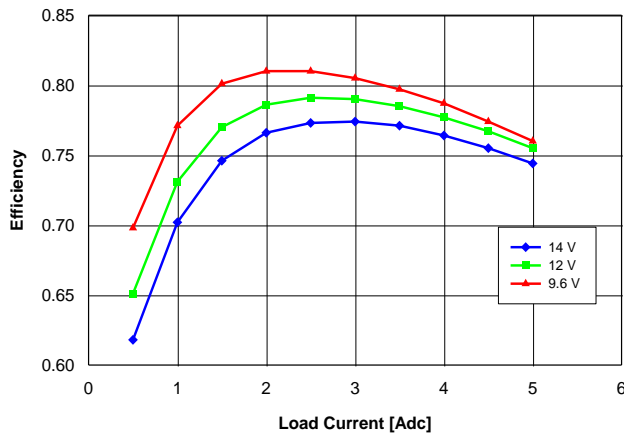

Fig. 1.2V.3: Efficiency vs. load current and input voltage for  $V_{out} = 1.2\text{ V}$  converter mounted vertically with air flowing at a rate of 200 LFM (1 m/s) and  $T_a = 25\text{ }^{\circ}\text{C}$ .

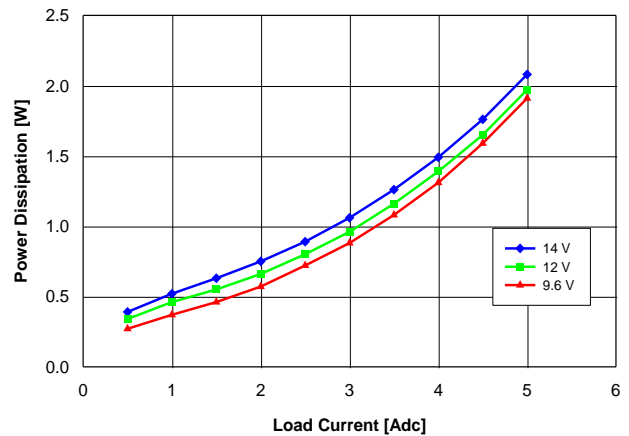

Fig. 1.2V.4: Power Loss vs. load current and input voltage for  $V_{out} = 1.2\text{ V}$  converter mounted vertically with air flowing at a rate of 200 LFM (1 m/s) and  $T_a = 25\text{ }^{\circ}\text{C}$ .

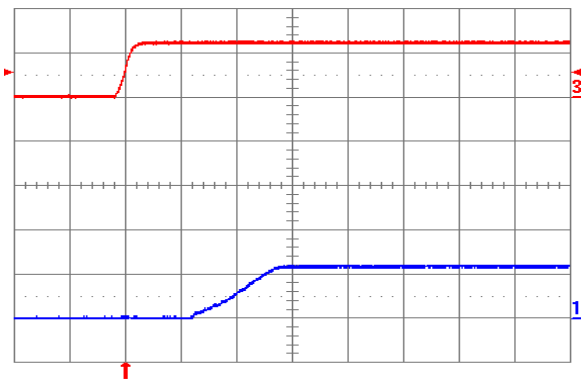

Fig. 1.2V.5: Turn-on transient for  $V_{out} = 1.2\text{ V}$  with application of  $V_{in}$  at full rated load current (resistive) and  $100\text{ }\mu\text{F}$  external capacitance at  $V_{in} = 12\text{ V}$ . Top trace:  $V_{in}$  (10 V/div.); Bottom trace: output voltage (1 V/div.); Time scale: 5 ms/div.

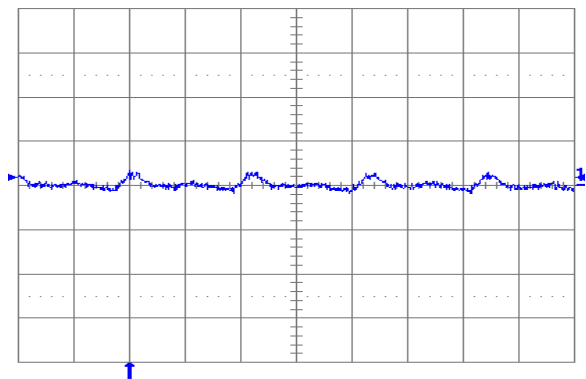

Fig. 1.2V.6: Output voltage ripple (20 mV/div.) at full rated load current into a resistive load with external capacitance  $100\text{ }\mu\text{F}$  ceramic and  $V_{in} = 12\text{ V}$  for  $V_{out} = 1.2\text{ V}$ . Time scale: 1  $\mu\text{s}$ /div.



# YNV12T05 DC-DC Converter

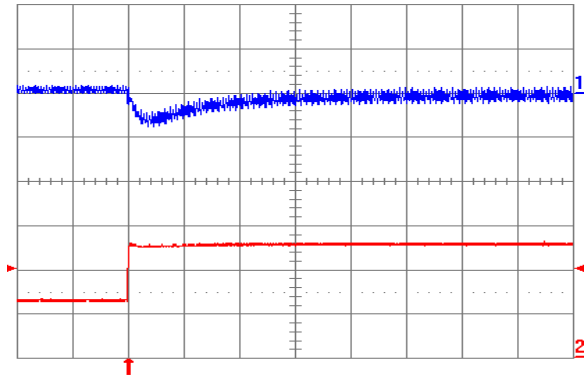

Fig. 1.2V.7: Output voltage response for  $V_{out} = 1.2\text{ V}$  to positive load current step change from 2.5 A to 5 A with slew rate of  $5\text{ A}/\mu\text{s}$  at  $V_{in} = 12\text{ V}$ . Top trace: output voltage (100 mV/div.); Bottom trace: load current (2 A/div.).  $C_o = 100\text{ }\mu\text{F}$  ceramic. Time scale:  $20\text{ }\mu\text{s}/\text{div}$ .

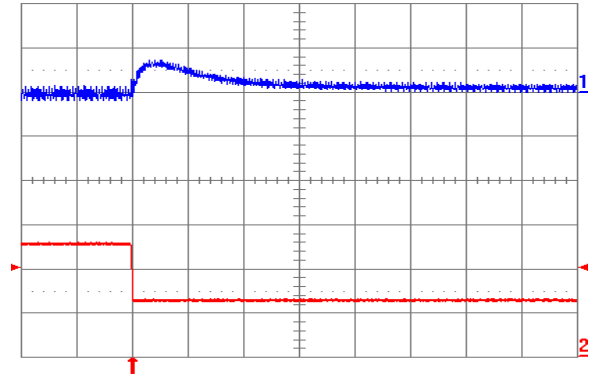

Fig. 1.2V.8: Output voltage response for  $V_{out} = 1.2\text{ V}$  to negative load current step change from 5 A to 2.5 A with slew rate of  $-5\text{ A}/\mu\text{s}$  at  $V_{in} = 12\text{ V}$ . Top trace: output voltage (100 mV/div.); Bottom trace: load current (2 A/div.).  $C_o = 100\text{ }\mu\text{F}$  ceramic. Time scale:  $20\text{ }\mu\text{s}/\text{div}$ .

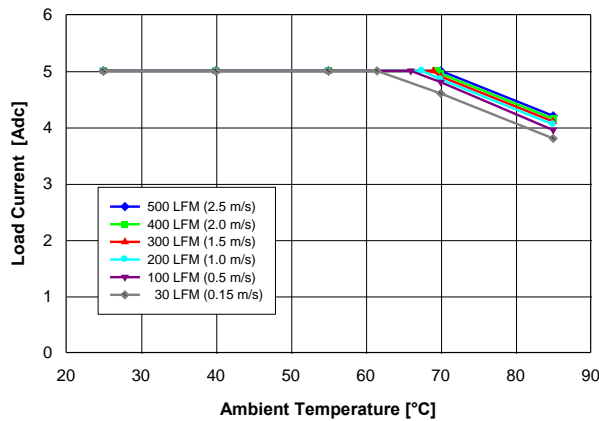

Fig. 1.0V.1: Available load current vs. ambient temperature and airflow rates for  $V_{out} = 1.0\text{ V}$  converter mounted vertically with  $V_{in} = 12\text{ V}$ , and maximum MOSFET temperature  $\leq 120\text{ }^\circ\text{C}$ .

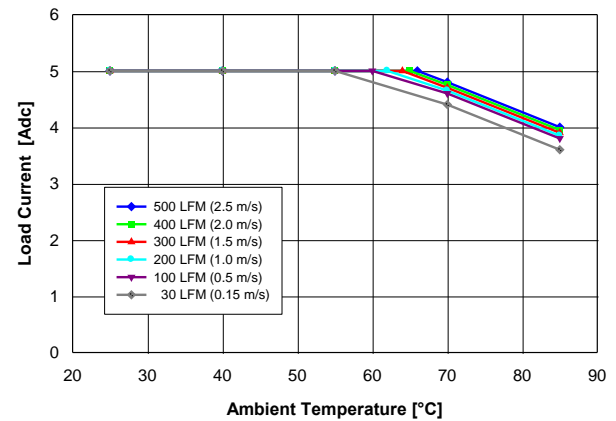

Fig. 1.0V.2: Available load current vs. ambient temperature and airflow rates for  $V_{out} = 1.0\text{ V}$  converter mounted horizontally with  $V_{in} = 12\text{ V}$ , and maximum MOSFET temperature  $\leq 120\text{ }^\circ\text{C}$ .

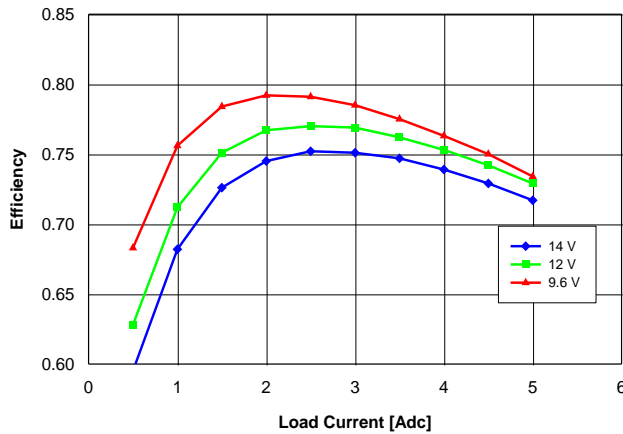

Fig. 1.0V.3: Efficiency vs. load current and input voltage for  $V_{out} = 1.0\text{ V}$  converter mounted vertically with air flowing at a rate of 200 LFM (1 m/s) and  $T_a = 25\text{ }^\circ\text{C}$ .

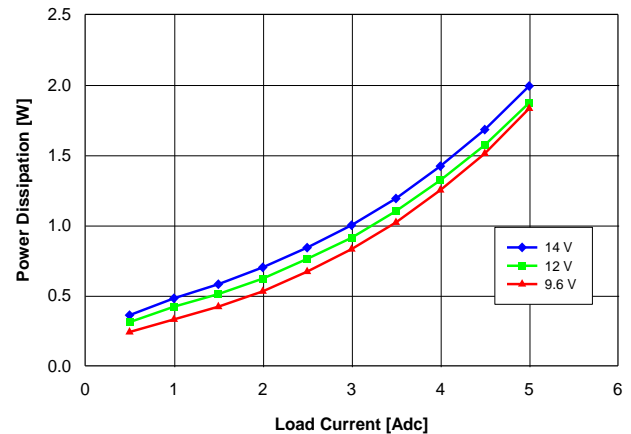

Fig. 1.0V.4: Power Loss vs. load current and input voltage for  $V_{out} = 1.0\text{ V}$  converter mounted vertically with air flowing at a rate of 200 LFM (1 m/s) and  $T_a = 25\text{ }^\circ\text{C}$ .

# YNV12T05 DC-DC Converter

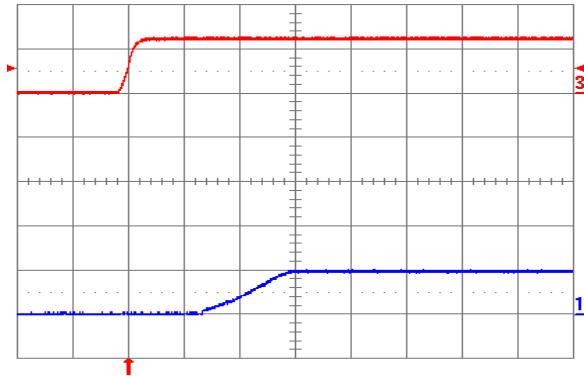

Fig. 1.0V.5: Turn-on transient for  $V_{out} = 1.0\text{ V}$  with application of  $V_{in}$  at full rated load current (resistive) and  $100\ \mu\text{F}$  external capacitance at  $V_{in} = 12\text{ V}$ . Top trace:  $V_{in}$  (10 V/div.); Bottom trace: output voltage (1 V/div.); Time scale: 5 ms/div.

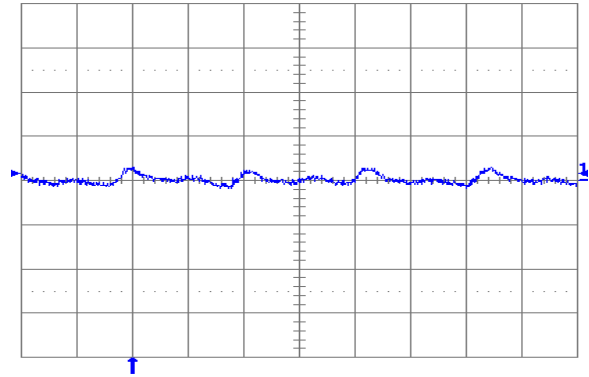

Fig. 1.0V.6: Output voltage ripple (20 mV/div.) at full rated load current into a resistive load with external capacitance  $100\ \mu\text{F}$  ceramic and  $V_{in} = 12\text{ V}$  for  $V_{out} = 1.0\text{ V}$ . Time scale:  $1\ \mu\text{s}/\text{div}$ .

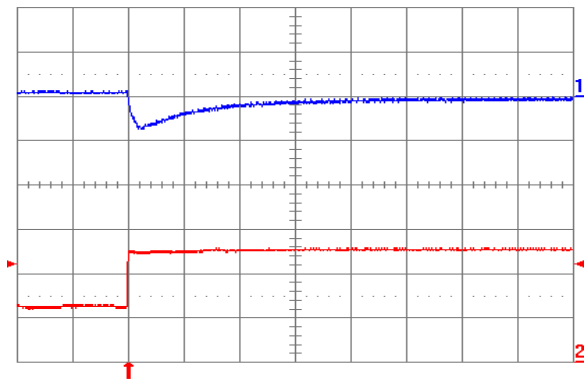

Fig. 1.0V.7: Output voltage response for  $V_{out} = 1.0\text{ V}$  to positive load current step change from 2.5 A to 5 A with slew rate of  $5\text{ A}/\mu\text{s}$  at  $V_{in} = 12\text{ V}$ . Top trace: output voltage (100 mV/div.); Bottom trace: load current (2 A/div.).  $C_o = 100\ \mu\text{F}$  ceramic. Time scale:  $20\ \mu\text{s}/\text{div}$ .

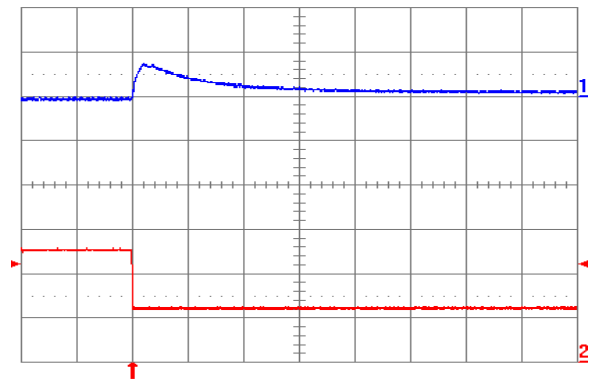

Fig. 1.0V.8: Output voltage response for  $V_{out} = 1.0\text{ V}$  to negative load current step change from 5 A to 2.5 A with slew rate of  $-5\text{ A}/\mu\text{s}$  at  $V_{in} = 12\text{ V}$ . Top trace: output voltage (100 mV/div.); Bottom trace: load current (2 A/div.).  $C_o = 100\ \mu\text{F}$  ceramic. Time scale:  $20\ \mu\text{s}/\text{div}$ .

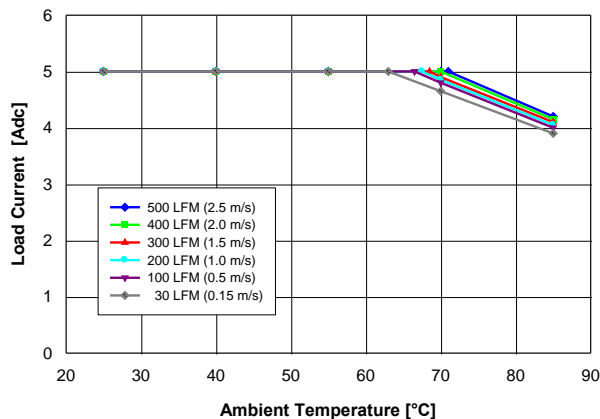

Fig. 0.7525V.1: Available load current vs. ambient temperature and airflow rates for  $V_{out} = 0.7525\text{ V}$  converter mounted vertically with  $V_{in} = 12\text{ V}$ , and maximum MOSFET temperature  $\leq 120\text{ }^\circ\text{C}$ .

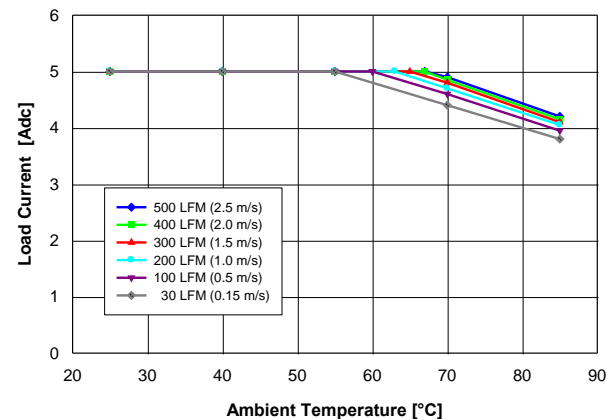

Fig. 0.7525V.2: Available load current vs. ambient temperature and airflow rates for  $V_{out} = 0.7525\text{ V}$  converter mounted horizontally with  $V_{in} = 12\text{ V}$ , and maximum MOSFET temperature  $\leq 120\text{ }^\circ\text{C}$ .

+1.866.513.2839

tech.support@psbel.com

belpowersolutions.com

# YNV12T05 DC-DC Converter

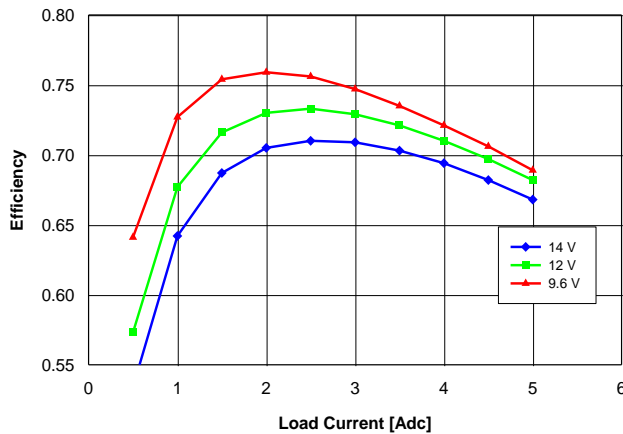

Fig. 0.7525V.3: Efficiency vs. load current and input voltage for  $V_{out} = 0.7525\text{ V}$  converter mounted vertically with air flowing at a rate of 200 LFM (1 m/s) and  $T_a = 25\text{ }^\circ\text{C}$

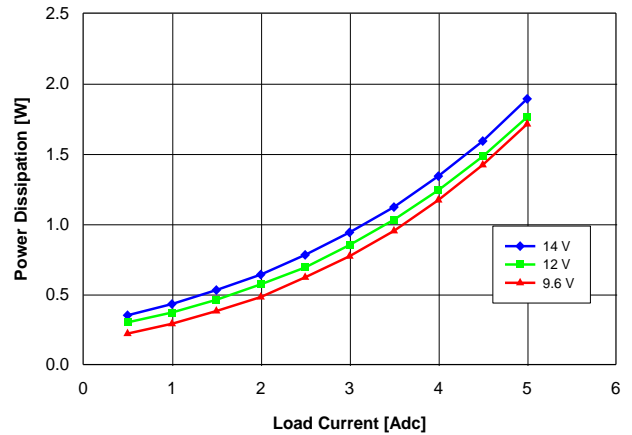

Fig. 0.7525V.4: Power Loss vs. load current and input voltage for  $V_{out} = 0.7525\text{ V}$  converter mounted vertically with air flowing at a rate of 200 LFM (1 m/s) and  $T_a = 25\text{ }^\circ\text{C}$ .

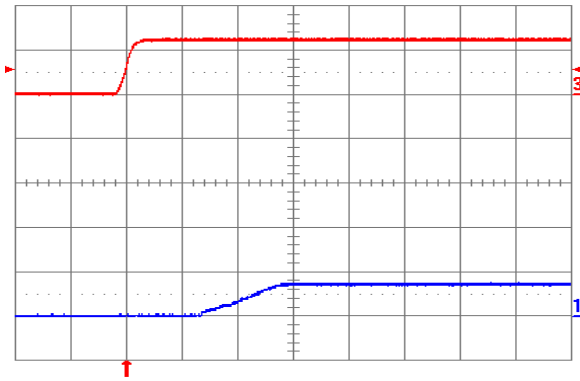

Fig. 0.7525V.5: Turn-on transient for  $V_{out} = 0.75250\text{ V}$  with application of  $V_{in}$  at full rated load current (resistive) and  $100\text{ }\mu\text{F}$  external capacitance at  $V_{in} = 12\text{ V}$ . Top trace:  $V_{in}$  (10 V/div.); Bottom trace: output voltage (1 V/div.); Time scale: 5 ms/div.

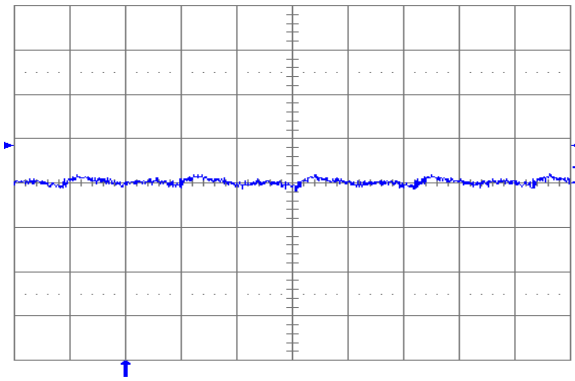

Fig. 0.7525V.6: Output voltage ripple (20 mV/div.) at full rated load current into a resistive load with external capacitance  $100\text{ }\mu\text{F}$  ceramic and  $V_{in} = 12\text{ V}$  for  $V_{out} = 0.7525\text{ V}$ . Time scale: 1  $\mu\text{s}$ /div.

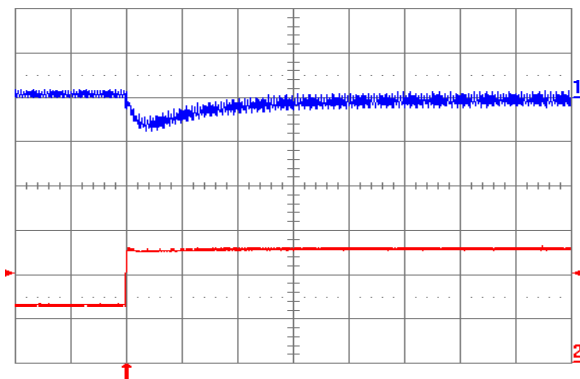

Fig. 0.7525V.7: Output voltage response for  $V_{out} = 0.7525\text{ V}$  to positive load current step change from 2.5 A to 5 A with slew rate of  $5\text{ A}/\mu\text{s}$  at  $V_{in} = 12\text{ V}$ . Top trace: output voltage (100 mV/div.); Bottom trace: load current (2 A/div.).  $C_o = 100\text{ }\mu\text{F}$  ceramic. Time scale: 20  $\mu\text{s}$ /div.

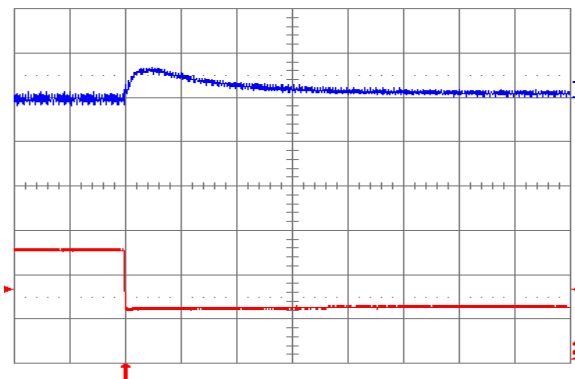

Fig. 0.7525V.8: Output voltage response for  $V_{out} = 0.7525\text{ V}$  to negative load current step change from 5 A to 2.5 A with slew rate of  $-5\text{ A}/\mu\text{s}$  at  $V_{in} = 12\text{ V}$ . Top trace: output voltage (100 mV/div.); Bottom trace: load current (2 A/div.).  $C_o = 100\text{ }\mu\text{F}$  ceramic. Time scale: 20  $\mu\text{s}$ /div.

+1.866.513.2839

tech.support@psbel.com

[belpowersolutions.com](http://belpowersolutions.com)

# YNV12T05 DC-DC Converter

## Physical Information

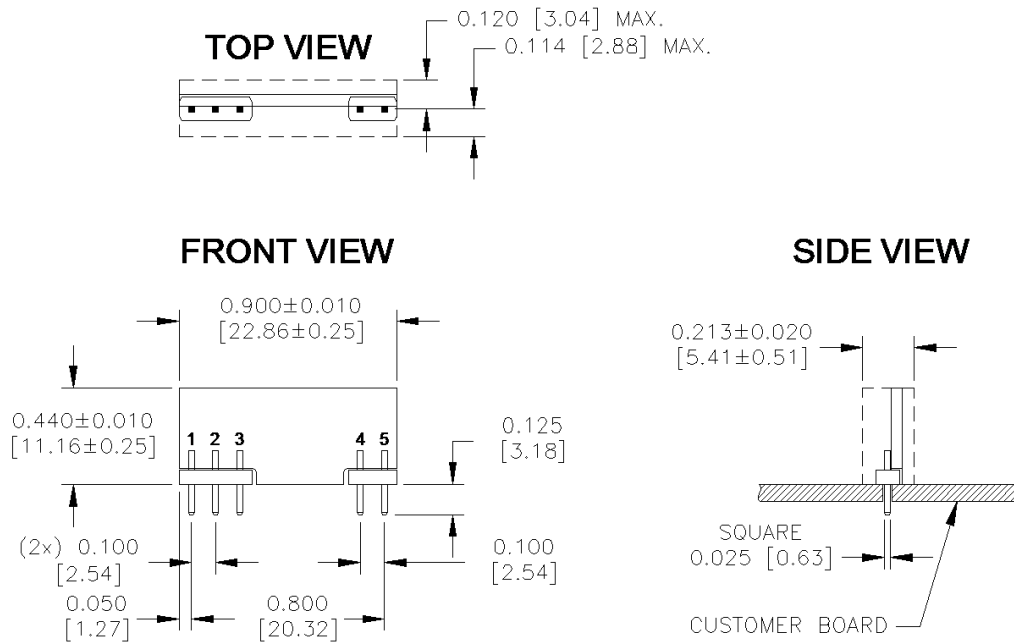

**YNV12T05 Pinout (Through-Hole - SIP)**

PAD/PIN CONNECTIONS	
Pad/Pin #	Function
1	Vout
2	TRIM
3	GND
4	Vin
5	ON/OFF

### YNV12T05 Platform Notes

- All dimensions are in inches [mm]
- Connector Material: Copper
- Connector Finish: Tin
- Converter Weight: 0.07 oz [2.00 g]
- Converter Height: 0.45" Max.
- Recommended Through Hole Via/Pad:  
Min. 0.043" X 0.064" [1.09 x 1.63]

## Ordering Information

Product Series	Input Voltage	Mounting Scheme	Rated Load Current	Environmental
YNV	12	T	05	-
Y-Series	9.6 – 14 VDC	T ⇒ Through-Hole (SIP)	5 A (0.7525 to 5.5 VDC)	No Suffix ⇒ RoHS lead-solder-exempt compliant G ⇒ RoHS compliant for all six substances

The example above describes P/N YNV12T05: 9.6 – 14 VDC input, through-hole (SIP), 5 A at 0.7525 to 5.5 VDC output, standard enable logic, and RoHS lead-solder-exemption compliancy. Please consult factory regarding availability of a specific version.

**For more information on these products consult: [tech.support@psbel.com](mailto:tech.support@psbel.com)**

**NUCLEAR AND MEDICAL APPLICATIONS** - Products are not designed or intended for use as critical components in life support systems, equipment used in hazardous environments, or nuclear control systems.

**TECHNICAL REVISIONS** - The appearance of products, including safety agency certifications pictured on labels, may change depending on the date manufactured. Specifications are subject to change without notice.

+1.866.513.2839

[tech.support@psbel.com](mailto:tech.support@psbel.com)

[belpowersolutions.com](http://belpowersolutions.com)